

**Bal Seal® Spring-Energized Seal
Solutions for Rotary Applications**

Custom components that drive tomorrow's technologies.®





Contents

- 2 Innovation Through Engineering Collaboration
- 3 Bal Seal® Spring-Energized Rotary Seal Types
- 5 Bal Seal® Rotary Seal Service Conditions
- 7 Bal Seal® Rotary Seal Materials
- 8 Wear Factor ("K") for Bal Seal® PTFE Materials
- 9 Rotary Seal Energizers
- 10 Bal Spring® Canted Coil Spring Energizers
- 11 Recommended Cross-Sections & Inside Diameters (Series KP, KTS, KS, KS13)
- 12 K-Series Seals With Molded Metal or Plastic Locking Ring
- 13 Recommended Cross Sections & Inside Diameters (Series LKS)
- 14 Recommended Cross Sections & Inside Diameters (Series S3115, 71, PB, RS3115)
- 15 Recommended Cross Sections and Codes
- 16 Rotary Seal Gland Dimensions (Series KP, KTS, KS, KS13)
- 17 Rotary Seal Gland Dimensions (Series LKS)
- 18 Rotary Seal Gland Dimensions (Series S3115, 71, PB)
- 19 Rotary Seal Gland Dimensions (Series RS3115)
- 20 Hardware Design Parameters
- 24 Rotary Seal Installation Options
- 26 Rotary Seal Application Example
- 27 Sealing Successes
- 28 Rotary Seal Design Request Form
- 29 Important Information



Innovation Through Engineering Collaboration

At Bal Seal Engineering, we design and manufacture custom-engineered sealing solutions that enhance the performance and reliability of equipment used everywhere, from deep sea to deep space. With more than 60 years of engineering experience and a vast applications knowledge base, we specialize in helping designers like you push the technology envelope, shape industry standards, and achieve a competitive edge.

Whether you're addressing an existing challenge or in the very early stages of development, we can help. Our engineers have the skills and expertise to collaborate and contribute during every step of the process, enabling you to design a better product and bring it to market fast.

Bal Seal® Spring-Energized Rotary Seal

The custom-engineered Bal Seal® spring-energized seal sets new standards for performance and reliability in rotary and oscillating service. Precision machined from PTFE and other premium polymers, our seal employs innovative geometries and wear-reducing canted coil spring energizer technology to extend the service life of the critical equipment you design.

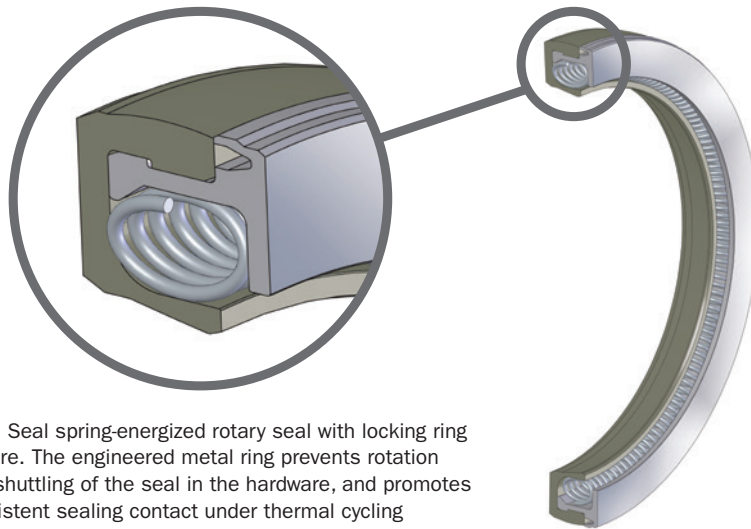

A Bal Seal spring-energized rotary seal with locking ring feature. The engineered metal ring prevents rotation and shuttling of the seal in the hardware, and promotes consistent sealing contact under thermal cycling conditions.

With nearly limitless combinations of jacket and spring materials to choose from, the Bal Seal gives you the ability to closely control frictional forces and optimize sealing effectiveness in a broad range of chemicals, temperatures, and pressures. Bal Seal locking rings and backup elements can help you push performance levels even higher.

Uses for the Bal Seal spring-energized seal include engine systems and hydraulics for commercial and military aircraft, surgical and orthopedic instruments, tools used to find and produce energy, and many more.

Bal Seal® Spring-Energized Rotary Seal Types

Since all of our solutions are custom-engineered to meet specific application requirements, we don't offer a "standard" line of products. But we do maintain an extensive database of popular, effective designs that can be modified to help you accelerate your development process. Here's a small sampling of the thousands of seal types we've engineered for rotary service.

Dynamic Memory Lip with Locking Ring

Series KP (no energizer)

- Locking ring retention
- Lowest friction seal with longest seal life
- Superior performance in high-speed applications
- Memory lip energizing

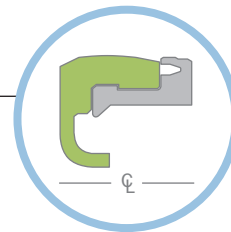

High-Speed Spring-Energized with Locking Ring

Series KTS

- Locking ring retention
- Lowest friction spring-energized seal with long seal life and good sealing ability
- Superior performance in high-speed applications
- Memory lip spring-energized

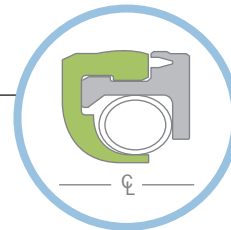

Metal Locking Ring

Series KS

- Locking ring retention
- Single contact point for high-speed application with best sealing ability
- Greater thermal stability for longer life
- Lower friction than seals with multiple sealing areas

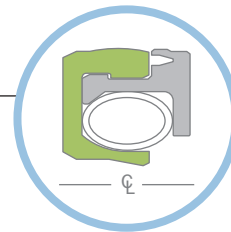

High-Pressure Anti-Extrusion

Series LKS

- Locking ring retention
- Extrusion resistant support ring
- High operating pressure
- Long seal life

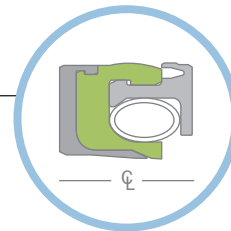

Metal Locking Ring

Series KS13

- Locking ring retention
- Low-friction seal with superior sealing ability
- Suitable for high and low temperatures
- Greater thermal stability

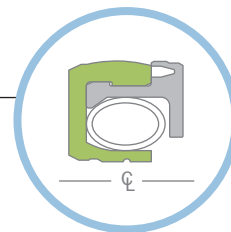



Bal Seal® Spring-Energized Rotary Seal Types *continued*

Flanged Seal

Series RS3115

- Flanged mounting retention, prevents rotation
- Single contact point for high-speed application with best sealing ability
- Greater thermal stability for longer life
- Lower friction than seals with multiple sealing areas on dynamic surface
- Medium speed and medium pressures

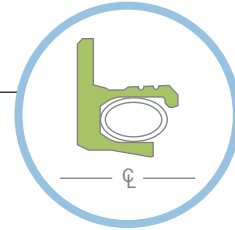

Memory Lip Seal

Series PB (no energizer)

- Press-in mounting
- Memory lip energizing
- Non-metal seal; highly compatible with most fluids
- Lowest cost seal
- Medium speed and very low pressures

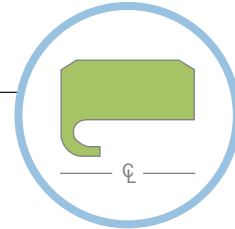

Dynamic Single Contact Lip with OD O-ring retention

Series 71

- O-ring retention and improved OD sealing
- Canted coil spring energizer
- Reduced heat build up for longer life
- Low speeds and pressures

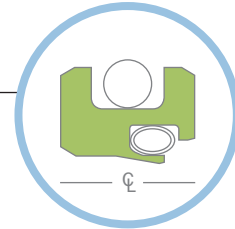

Dynamic Single Contact Lip



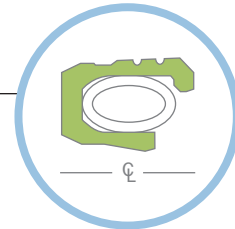

Series S3115

- Press-in mounting
- Improved sealing ability
- Reduced friction
- Reduced heat build-up for longer life
- Low speeds and pressures



Bal Seal® Rotary Seal Service Conditions





Temperature, pressure, speed, and media. These are just a few of the many factors you'll need to consider when choosing a seal for rotary applications. Our seal materials, energizers, and geometries—coupled with our consultative engineering approach—will help you address all of them, and create a solution that sets your designs apart. Here's a look at how a sampling of our Bal Seal® spring-energized seals perform under a variety of conditions.

Seal Design	Series	Features/Applications	Speed Limit fpm (m/s)	Pressure Limit psi (bar)	Temperature Range °F (°C)	Cross Section Range in. (mm)	Inside Diameter Range in. (mm)
	KP	<ul style="list-style-type: none"> Dust seal High speed Environmental sealing Splash lubrication Lowest friction applications 	7500 (38)	15 (1.0)	Continuous -65 to +350 (-54 to +177) Intermittent -65 to +450 (-54 to +232)	0.044 to 0.585 (1.12 to 14.86)	0.125 to 34.000 (3.18 to 863.6)
	KTS	<ul style="list-style-type: none"> Medical hand tools Autoclavable tools Dental drills Moderate sealing applications 	3000 (15)	15 (1.0)	Continuous -65 to +350 (-54 to +177) Intermittent -65 to +450 (-54 to +232)	0.044 to 0.585 (1.12 to 14.86)	0.125 to 34.000 (3.18 to 863.6)
	KS	<ul style="list-style-type: none"> Industrial tools Autoclavable tools Sealing gases and solvents 	2000 (10)	50 (3.4)	Continuous -65 to +350 (-54 to +177) Intermittent -65 to +450 (-54 to +232)	0.044 to 0.585 (1.12 to 14.86)	0.125 to 34.000 (3.18 to 863.6)
	LKS	<ul style="list-style-type: none"> Abrasive media High temperature More contact area for better sealing 	150 (0.76)	500 (34.5)	Continuous -65 to +350 (-54 to +177) Intermittent -65 to +450 (-54 to +232)	0.089 to 0.636 (2.26 to 16.15)	0.187 to 34.000 (4.75 to 863.6)
	KS13	<ul style="list-style-type: none"> High and low temperature Best sealing applications 	125 (0.64)	1500 (103)	Continuous -65 to +350 (-54 to +177) Intermittent -65 to +450 (-54 to +232)	0.044 to 0.585 (1.12 to 14.86)	0.125 to 34.000 (3.18 to 863.6)

Note: Values of pressure, temperature, and surface speed represent the maximum independent operating conditions. Maximum values should not be combined. Please contact us for more information.



Bal Seal® Rotary Seal Service Conditions *continued*

Seal Design	Series	Features/Applications	Speed Limit fpm (m/s)	Pressure Limit psi (bar)	Temperature Range °F (°C)	Cross Section Range in. (mm)	Inside Diameter Range in. (mm)
	RS3115	<ul style="list-style-type: none"> Dust seal High speed Environmental sealing Splash lubrication Lowest friction applications 	2000 (10)	500 (34.5)	Continuous -65 to +400 (-54 to +204) Intermittent -65 to +450 (-54 to +232)	0.031 to 0.500 (0.79 to 12.70)	0.062 to 120.00 (1.57 to 3048.00)
	PB	<ul style="list-style-type: none"> Medical hand tools Autoclavable tools Dental drills Moderate sealing applications 	1000 (5)	15 (1.0)	Continuous -20 to +125 (-29 to +52) Intermittent -0 to +150 (-17 to +66)	0.031 to 0.500 (0.79 to 12.70)	0.062 to 120.00 (1.57 to 3048.00)
	71	<ul style="list-style-type: none"> Industrial tools Autoclavable tools Sealing gases and solvents 	750 (3.8)	60 (4.1)	Continuous -20 to +150 (-29 to +66) Intermittent -20 to +200 (-29 to +93)	0.063 to 0.500 (1.59 to 12.70)	0.062 to 120.00 (1.57 to 3048.00)
	S3115	<ul style="list-style-type: none"> Low pressure Low temperature Low friction 	250 (1.3)	25 (1.7)	Continuous -20 to +125 (-29 to +52) Intermittent -20 to +150 (-29 to +66)	0.031 to 0.500 (0.79 to 12.70)	0.062 to 120.00 (1.57 to 3048.00)

Note: Values of pressure, temperature, and surface speed represent the maximum independent operating conditions. Maximum values should not be combined. Please contact us for more information.

Bal Seal® Rotary Seal Materials

The Bal Seal® spring-energized rotary seal's base jacket materials consist of polytetrafluoroethylene (PTFE), ultra-high molecular weight polyethylene (UHMWPE), polyetheretherketone (PEEK), and other specialty polymers. We combine these with advanced filler materials to enhance performance properties. Here's a sampling of the materials we've formulated for specific rotary application requirements.

Seal Code	Material/Description	Material Temperature Range °F (°C)	Wear Resistance 5=Excellent 1=Fair	FDA Compatible	Chemical Compatibility
T	VIRGIN PTFE Light-duty service. Lowest friction. Excellent chemical compatibility. FDA compliant. Color: White	-450 to 450 (-268 to 230)	1	Yes	Low
TA	VIRGIN PTFE—LOW PERMEABILITY/Deformation Superior mechanical properties with good surface finishes. Good sealing ability in gases and vacuum. Suitable for semiconductor applications. Color: white	-450 to 450 (-268 to 232)	2	Yes	Low
G	GRAPHITE-FILLED PTFE Light duty service. Low friction. Very good chemical compatibility. Good wear resistance in liquids. Color: black	-450 to 475 (-268 to 246)	2	No	Low
GFP	GRAPHITE-FIBER-REINFORCED PTFE Severe service conditions. Excellent performance in applications with high pressure, low speed and high temperature. Color: black	-450 to 500 (-268 to 260)	5	No	Medium
GFBM	Graphite MOS2-REINFORCED PTFE Severe dry and liquid service. Excellent wear and extrusion resistance in liquids, inert gases, vacuum. Color: black	-450 to 500 (-268 to 260)	4	No	Medium
SP45	POLYMER-FILLED PTFE General-purpose material designed for contact with housings and pistons made of soft metals or plastics. Good for high-speed, low-pressure applications. Color: light gray/green	-450 to 500 (-268 to 260)	5	Yes	Low
SP191	POLYMER-FILLED PTFE Gas compressor systems and oxygen intensifier systems applications. Excellent wear resistance in various gases. Low abrasion to dynamic surfaces and operates well against soft mating surfaces like aluminum, mild steel, brass, and plastics. Color: tan	-450 to 500 (-268 to 260)	5	Yes	Low
UP30	UHMW POLYETHYLENE composition Suitable for very high-pressure low-speed reciprocating applications such as HPLC and cryogenic applications. Color: gold	-450 to 180 (-268 to 82)	4	Yes	Low
P69D	HIGH PERFORMANCE POLYMER COMPOSITION High-performance material for high temperature service. Primarily used as support ring with Bal Seal LKS® seal. Color: black	-70 to +600 (-57 to +316)	2	No	Medium



Wear Factor (“K”) for Bal Seal® PTFE Materials

Wear factor (“K”) is an important consideration in seal material selection. The type of media a material encounters can have a significant impact on its wear factor. The greater the wear factor, the greater the seal wear. Here’s a comparison of some popular Bal Seal® spring-energized seal jacket materials and their corresponding wear factors.

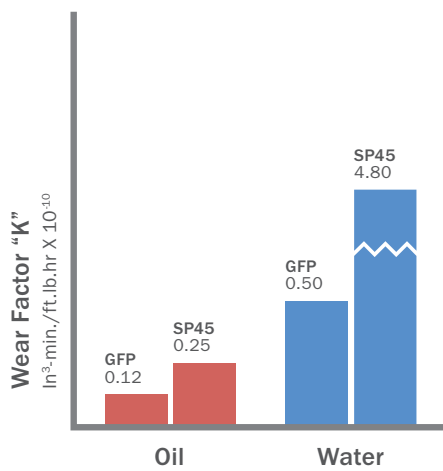

Wear Rate at 100,000 PV
Low speed (100 fpm) – High pressure (1000 psi)

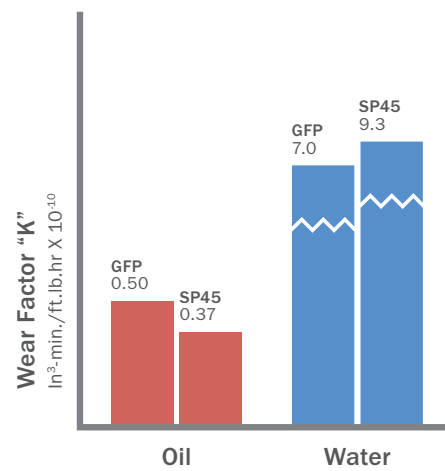



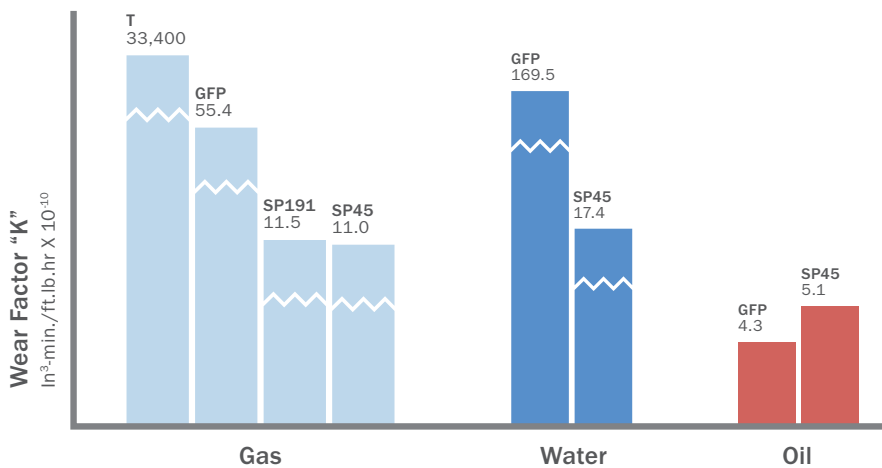

Wear Rate at 100,000 PV
High speed (1000 fpm) – Low pressure (100 psi)

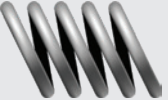

Wear Rate at 20,000 PV
Speed (20 fpm) – Pressure (1000 psi)

Rotary Seal Energizers

At the heart of almost every Bal Seal® rotary seal is an energizer that's precision-engineered to promote even wear and longer seal service life. Choosing the right energizer—with the ideal combination of force, fit, and finish—is as critical to the success of your design as the seal material itself.

Energizer	Type	Friction	Sealing	Wear	High-speed	Vacuum Gas	High Pressure	Cryogenic
	Bal Spring® Canted Coil Spring Energizer Light Force	Low	Low	Low	Excellent	Not Recommended	Good	Poor
	Bal Spring® Canted Coil Spring Energizer Medium Force	Moderate	Moderate	Moderate	Good	Fair	Excellent	Fair
	Bal Spring® Canted Coil Spring Energizer Heavy Force	High	High	High	Not Recommended	Good	Excellent	Good
	Bal Spring® Helical Spring Energizer	High	High	Moderate	Not Recommended	Excellent	Excellent	Excellent
	Bal Spring® Cantilever Spring Energizer	High	High	High	Not Recommended	Excellent	Fair	Fair
	Elastomeric O-Ring Energizer	High	High	High	Not Recommended	Excellent	Fair	Not Recommended

Spring Materials

Stainless Steel (302, 316, 316L), Hastelloy®, Inconel®, and others.

Locking Ring Materials

Stainless Steel (303, 304, 316, 316L), Aluminum, Mild Steel, and others.



Bal Spring® Canted Coil Spring Energizers



The Bal Spring® canted coil spring exhibits a unique deflection and force behavior when it's compressed. Unlike other spring technologies, our spring exerts a near-constant force across the working deflection range, and its forces remain consistent—even in wide temperature ranges. It resists compression set, and its individual coils compensate for misalignment, tolerance variations, and surface irregularities. Spring loads are customizable, enabling you to optimize friction, sealing effectiveness, and performance life.

A variety of spring energizer materials are available to meet chemical, temperature, and galvanic compatibility requirements.

Force Deflection Chart

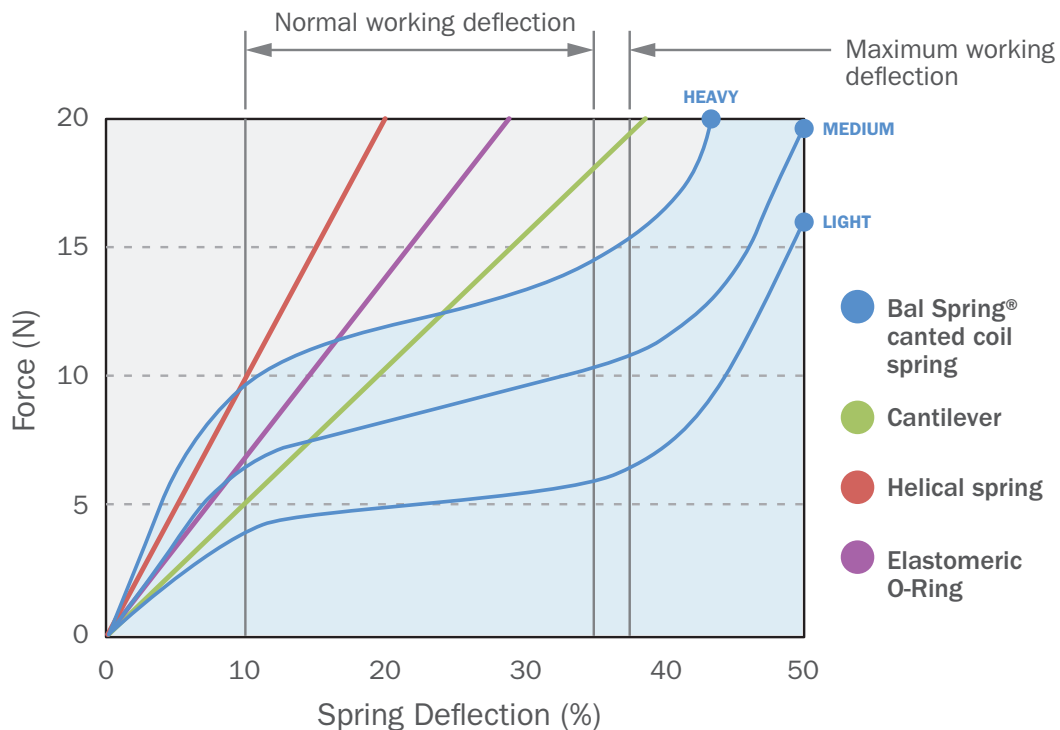

Spring Materials

Stainless Steel (302, 316, 316L), MP35N®, Platinum Iridium, Titanium, Hastelloy®, Inconel®, Beryllium-Copper, Zirconium-Copper

Recommended Cross-Sections & Inside Diameters (Series KP, KTS, KS, KS13)

Bal Seal spring-energized rotary seals are available in cross sections ranging from 0.044 in (1.12 mm) to 0.585 in (14.86 mm). Seal cross section and shaft diameters are presented in ranges that will typically result in optimal seal performance.

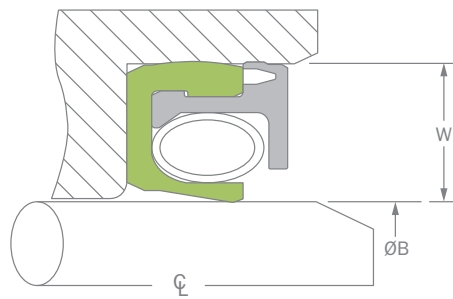

Series KS

Cross Section Code	W Nominal Cross Section in. (mm)	ØB Shaft Diameter Ranges	
		Min. In. (mm)	Max. In. (mm)
1	0.044 (1.12)	0.060 (1.52)	0.200 (5.08)
0	0.086 (2.18)	0.125 (3.18)	0.375 (9.53)
4	0.118 (3.00)	0.125 (3.18)	0.875 (22.23)
5	0.156 (3.96)	0.500 (12.70)	2.500 (63.50)
6	0.233 (5.92)	2.000 (50.80)	5.000 (127.00)
7	0.313 (7.95)	3.000 (76.20)	8.000 (203.20)
8	0.458 (11.63)	4.000 (101.60)	12.000 (304.80)
9	0.585 (14.86)	10.000 (254.0)	15.000 (381.00)

Note: These seal designs are also offered in other cross sections and diameters. Please contact us for more information.



K-Series Seals With Molded Metal or Plastic Locking Ring

For engineers with tight development deadlines and a degree of design flexibility, we offer several popular cross sections of our K-Series seal locking ring in molded metal and plastic. These locking rings are engineered to fit many common shaft sizes for rotary applications, and they can be paired with seals in a variety of materials and spring loads, allowing for faster delivery.

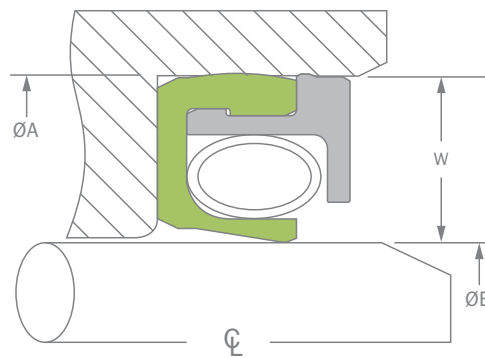

Series KS

Seal Series	W Nominal Cross Section in. (mm)	B Shaft Diameter Tolerance in. (mm)	B Shaft Diameter in. (mm)	A Bore Diameter Tolerance in. (mm)	A Bore Diameter in. (mm)
KS0	0.086 (2.18)	+0.0000 to -0.0005 (0.00 to -0.013)	0.0938 (2.38)	0.0000 to +0.0005 (-0.000 to +0.013)	0.2658 (6.75)
			0.1250 (3.18)		0.2970 (7.54)
			0.1875 (4.76)		0.3595 (9.13)
			0.2500 (6.35)		0.4220 (10.72)
KS4	0.118 (3.00)	+0.0000 to -0.0005 (0.00 to -0.013)	0.2500 (6.35)	0.0000 to +0.0005 (-0.000 to +0.013)	0.4860 (12.34)
			0.3750 (9.53)		0.6110 (15.52)
			0.5000 (12.70)		0.7360 (18.69)
			0.6250 (15.88)		0.8610 (21.87)
			0.7500 (19.05)		0.9860 (25.04)
KS5	0.156 (3.96)	+0.0000 to -0.0005 (0.00 to -0.013)	1.0000 (25.40)	0.000 to 0.001 (0.000 to +0.025)	1.3120 (33.32)

Recommended Cross Sections & Inside Diameters (Series LKS)

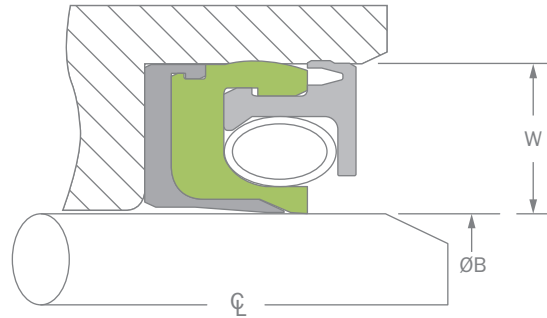

Series LKS

Cross Section Code	Nominal Cross Section in. (mm)	ØB Shaft Diameter Ranges	
		Min. In. (mm)	Max. In. (mm)
0	0.089 (2.26)	0.187 (4.75)	0.750 (19.05)
4	0.122 (3.10)	0.500 (12.70)	1.500 (38.10)
5	0.159 (4.04)	1.000 (25.40)	2.500 (63.50)
6	0.240 (6.10)	1.500 (38.10)	4.000 (101.60)
7	0.320 (8.13)	2.000 (50.80)	8.000 (203.20)
8	0.474 (12.04)	2.500 (63.50)	15.000 (381.00)
9	0.636 (16.15)	3.500 (88.90)	18.000 (457.20)

Note: These seal designs are also offered in other cross sections and diameters. Please contact us for more information.



Recommended Cross Sections & Inside Diameters (Series S3115, 71, PB, RS3115)

Seals in these series are available in cross sections ranging from 0.016 in (0.40 mm) to 0.500 in (12.70 mm). Seal cross section and seal inside diameters are divided into available and recommended sizes. Recommended sizes will typically result in optimal seal performance.

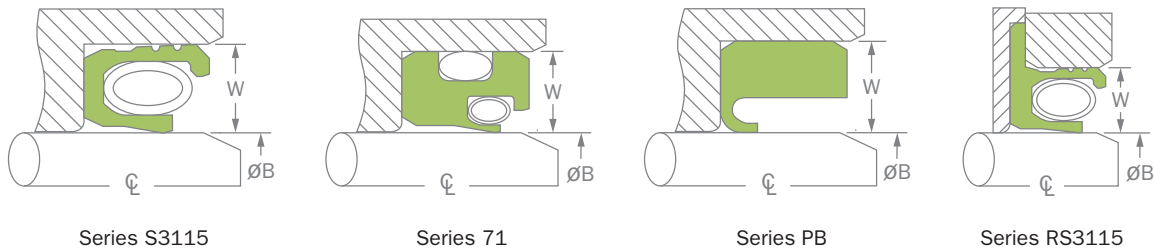

Cross Section		W Nominal Cross Section in. (mm)	ØB Shaft Diameter Ranges			
			Available Sizes	Recommended Sizes		Available Sizes
Code	Size		Min. in. (mm)	Min. in. (mm)	Max. in. (mm)	Max. in. (mm)
2	1/64	0.016 (0.40)	0.016 (0.40)	0.031 (0.79)	0.040 (1.02)	0.062 (1.57)
1	1/32	0.031 (0.79)	0.025 (0.64)	0.041 (1.04)	0.312 (7.92)	0.675 (17.15)
0	1/16	0.062 (1.57)	0.050 (1.27)	0.187 (4.75)	0.750 (19.05)	2.50 (63.50)
4	3/32	0.094 (2.38)	0.094 (2.39)	0.500 (12.70)	1.500 (38.10)	4.00 (101.60)
5	1/8	0.125 (3.18)	0.187 (4.75)	1.000 (25.40)	2.500 (63.50)	9.00 (228.60)
6	3/16	0.188 (4.76)	0.500 (12.70)	1.500 (38.10)	4.000 (101.60)	12.50 (317.50)
7	1/4	0.250 (6.35)	1.500 (38.10)	2.000 (50.80)	8.000 (203.20)	18.00 (457.20)
8	3/8	0.375 (9.53)	As requested	2.500 (63.50)	15.000 (381.00)	30.00 (762.00)
9	1/2	0.500 (12.70)	As requested	3.500 (88.90)	24.000 (609.60)	75.00 (1905.00)

Note: 1. Series 71 is not offered in cross-section codes 2, 1, and 0.
2. Series RS3115 is not offered cross-section code 2.

Recommended Cross Sections and Codes

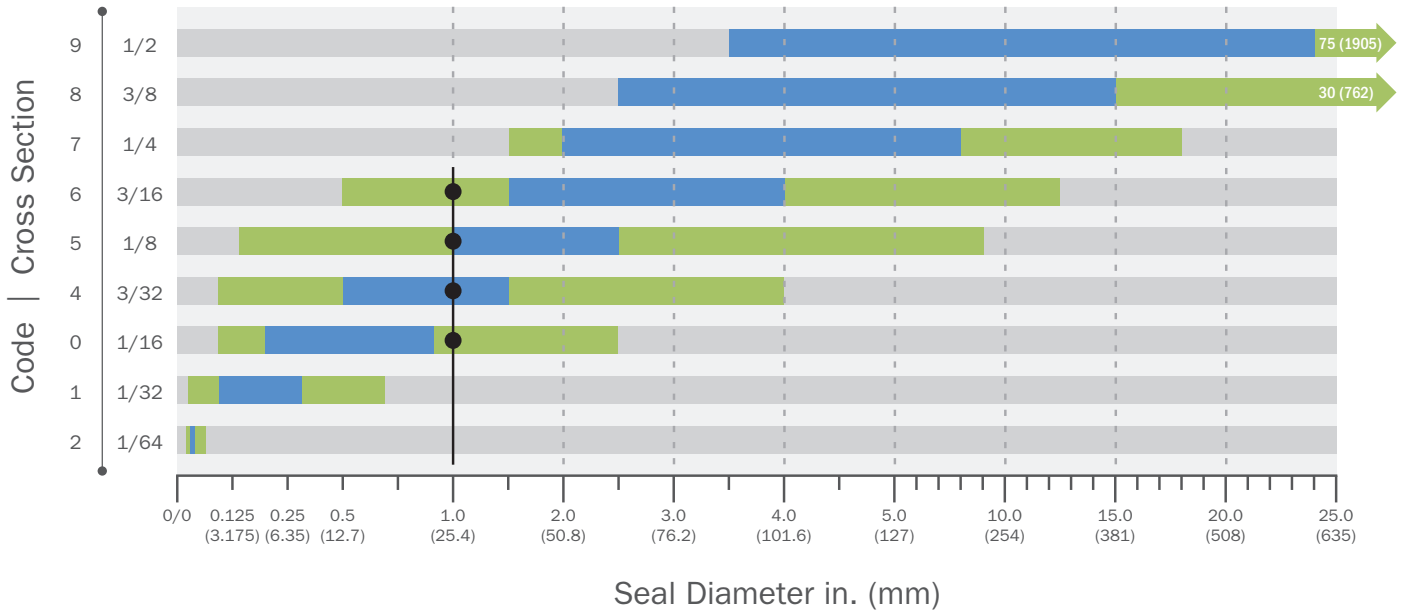

● Recommended diameter range ● Available diameter range

Example: A 1.0 in. seal diameter is available in cross sections 1/16, 3/32, 1/8, and 3/16 in.

Large Diameter Spring-Energized Seals

Our Bal Seal® spring-energized large diameter seals offer big performance advantages in critical equipment. Designed to handle slow-speed rotary applications, our low-friction one-piece seals provide excellent resistance to wear, extrusion, and chemicals. They're energized with a Bal Spring® canted coil spring, which promotes even wear and prolongs service life. Seals are available in select profiles and a variety of materials.



For large diameter rotary sealing in energy, medical, analytical, and industrial applications, we offer Bal Seal® spring-energized seals with inside diameters of up to 120" (304.8 cm).



Rotary Seal Gland Dimensions (Series KP, KTS, KS, KS13)

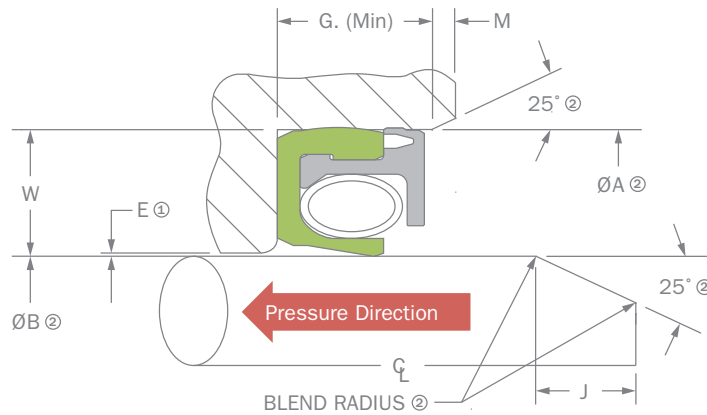

①Radial clearance determined by service conditions (a recommended radial clearance is shown on Bal Seal Engineering design proposal drawings; refer to page 21 for radial clearance dimension).
 ②Refer to page 22 for recommended surface finishes.

Cross Section Code	W Nominal Cross Section in. (mm)	G Gland Length (min) in. (mm)	J Shaft Chamfer Length in. (mm)	M Bore Chamfer Length in. (mm)
1	0.044 (1.12)	0.060 (1.52)	0.031 ± 0.004 (0.79 ± 0.10)	0.007 ± 0.001 (0.18 ± 0.03)
0	0.086 (2.18)	0.110 (2.79)	0.062 ± 0.005 (1.57 ± 0.13)	0.010 ± 0.002 (0.25 ± 0.05)
4	0.118 (3.00)	0.150 (3.81)	0.093 ± 0.006 (2.36 ± 0.15)	0.015 ± 0.003 (0.38 ± 0.08)
5	0.156 (3.96)	0.195 (4.95)	0.125 ± 0.008 (3.18 ± 0.20)	0.020 ± 0.003 (0.51 ± 0.08)
6	0.233 (5.92)	0.275 (6.99)	0.187 ± 0.010 (4.75 ± 0.25)	0.025 ± 0.003 (0.64 ± 0.08)
7	0.313 (7.95)	0.365 (9.27)	0.250 ± 0.012 (6.35 ± 0.30)	0.035 ± 0.003 (0.89 ± 0.08)
8	0.458 (11.63)	0.530 (13.46)	0.375 ± 0.015 (9.53 ± 0.38)	0.045 ± 0.004 (1.14 ± 0.10)
9	0.585 (14.86)	0.730 (18.54)	0.500 ± 0.020 (12.70 ± 0.51)	0.060 ± 0.006 (1.52 ± 0.15)

Rotary Seal Gland Dimensions (Series LKS)

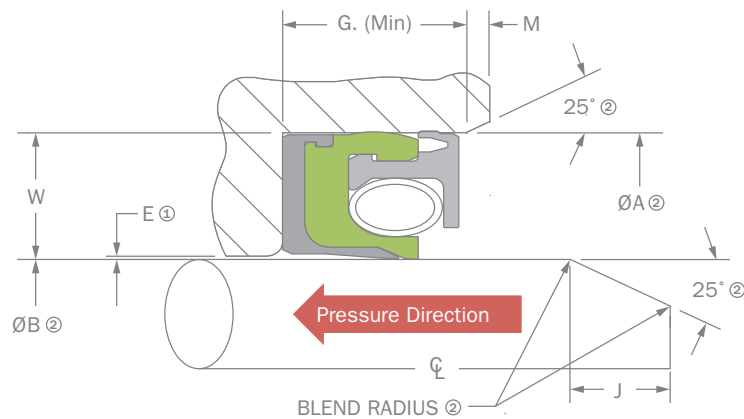

①Radial clearance determined by service conditions (a recommended radial clearance is shown on Bal Seal Engineering design proposal drawings; refer to page 21 for radial clearance dimension).
 ②Refer to page 22 for recommended surface finishes.

Cross Section Code	W Nominal Cross Section in. (mm)	G Gland Length (min) in. (mm)	J Shaft Chamfer Length in. (mm)	M Bore Chamfer Length in. (mm)
0	0.089 (2.26)	0.150 (3.81)	0.062 ± 0.005 (1.57 ± 0.13)	0.010 ± 0.002 (0.25 ± 0.05)
4	0.122 (3.10)	0.205 (5.21)	0.093 ± 0.006 (2.36 ± 0.15)	0.015 ± 0.003 (0.38 ± 0.08)
5	0.159 (4.04)	0.260 (6.60)	0.125 ± 0.008 (3.18 ± 0.20)	0.020 ± 0.003 (0.51 ± 0.08)
6	0.240 (6.10)	0.355 (9.02)	0.187 ± 0.010 (4.75 ± 0.25)	0.025 ± 0.003 (0.64 ± 0.08)
7	0.320 (8.13)	0.470 (11.94)	0.250 ± 0.012 (6.35 ± 0.30)	0.035 ± 0.003 (0.89 ± 0.08)
8	0.474 (12.04)	0.705 (17.91)	0.375 ± 0.015 (9.53 ± 0.38)	0.045 ± 0.004 (1.14 ± 0.10)
9	0.636 (16.15)	0.950 (24.13)	0.500 ± 0.020 (12.70 ± 0.51)	0.060 ± 0.006 (1.52 ± 0.15)



Rotary Seal Gland Dimensions (Series S3115, 71, PB)

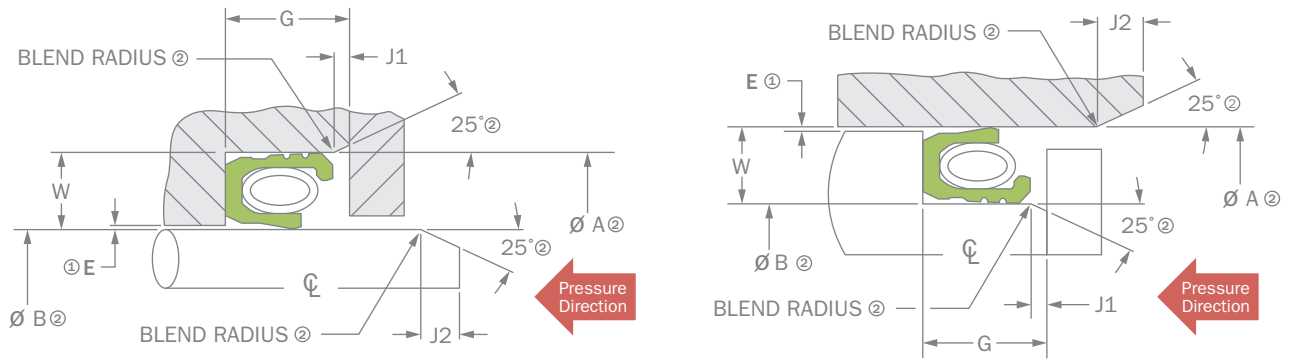

①Radial clearance determined by service conditions (a recommended radial clearance is shown on Bal Seal Engineering design proposal drawings; refer to page 21 for radial clearance dimension). ②Refer to page 22 for recommended surface finishes.

Cross Section		W Nominal Cross Section in. (mm)	G Gland Length (Min.) in. (mm)	
Code	Size		Standard Seals	U Series Seals
2	1/64	0.016 (0.40)	Consult BSE	Consult BSE
1	1/32	0.031 (0.79)	0.060 (1.52)	0.080 (2.03)
0	1/16	0.062 (1.59)	0.110 (2.79)	0.130 (3.30)
4	3/32	0.094 (2.38)	0.150 (3.81)	0.190 (4.83)
5	1/8	0.125 (3.18)	0.195 (4.95)	0.275(6.99)
6	3/16	0.188 (4.76)	0.275 (6.99)	0.360 (9.14)
7	1/4	0.250 (6.35)	0.365 (9.27)	0.530 (13.46)
8	3/8	0.375 (9.53)	0.530 (13.46)	0.700 (17.78)
9	1/2	0.500 (12.70)	0.730 (18.54)	0.950 (24.13)

Rotary Seal Gland Dimensions (Series RS3115)

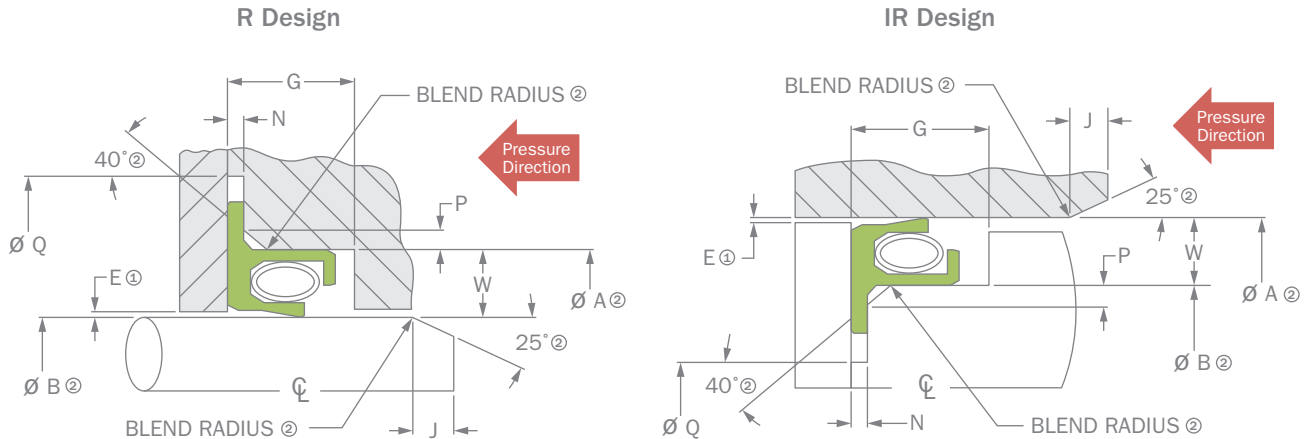

①Radial clearance determined by service conditions (a recommended radial clearance is shown on Bal Seal Engineering design proposal drawings; refer to page 21 for radial clearance dimension). ②Refer to page 22 for recommended surface finishes.

Cross Section		W Nominal Cross Section in. (mm)	G Gland Length (Min.) in. (mm)		N Flange Depth in. (mm)	P Chamfer Height in. (mm)	Chamfer Length (Min.) in. (mm)		J Chamfer Length in. (mm)
Code	Size		R/IR Series Seals	UR/UIR Series Seals			R/IR Series Seals	UR/UIR Series Seals	
1	1/32	0.031 (0.79)	0.075 (1.91)	0.092 (2.34)	0.012/0.013 (0.30/0.33)	0.012/0.017 (0.30/0.43)	A +0.096 (2.44)	B -0.096 (2.44)	0.031±0.004 (0.79±0.10)
0	1/16	0.062 (1.59)	0.117 (2.97)	0.138 (3.51)	0.012/0.013 (0.30/0.33)	0.017/0.023 (0.43/0.58)	A +0.135 (3.43)	B -0.135 (3.43)	0.062±0.005 (1.57±0.13)
4	3/32	0.094 (2.38)	0.171 (4.34)	0.203 (5.16)	0.019/0.020 (0.48/0.51)	0.028/0.035 (0.71/0.89)	A +0.143 (3.63)	B -0.143 (3.63)	0.093±0.006 (2.36±0.15)
5	1/8	0.125 (3.18)	0.220 (5.59)	0.259 (6.58)	0.026/0.027 (0.66/0.69)	0.040/0.049 (1.02/1.24)	A +0.155 (3.94)	B -0.155 (3.94)	0.125±0.008 (3.17±0.20)
6	3/16	0.188 (4.76)	0.280 (7.11)	0.351 (8.92)	0.031/0.032 (0.79/0.81)	0.057/0.067 (1.45/1.70)	A +0.246 (6.25)	B -0.246 (6.25)	0.187±0.010 (4.75±0.25)
7	1/4	0.250 (6.35)	0.375 (9.53)	0.489 (12.42)	0.044/0.045 (1.12/1.14)	0.069/0.080 (1.75/2.03)	A +0.306 (7.77)	B -0.306 (7.77)	0.250±0.012 (6.35±0.30)
8	3/8	0.375 (9.53)	0.565 (14.35)	0.741 (18.82)	0.088/0.090 (2.24/2.29)	0.080/0.092 (2.03/2.34)	A +0.384 (9.75)	B -0.384 (9.75)	0.375±0.015 (9.53±0.38)
9	1/2	0.500 (12.70)	0.763 (19.38)	0.980 (24.89)	0.088/0.090 (2.24/2.29)	0.092/0.103 (2.34/2.62)	A +0.480 (12.19)	B -0.480 (12.19)	0.500±0.020 (12.70±0.51)



Hardware Design Parameters

With the right pairing of seal and hardware, big performance breakthroughs are possible. That's why we recommend close consideration of hardware design parameters—including tolerances, radial clearance, surface finish, hardness, and dynamic alignment—during the seal design process. For more information, reference Technical Report TR-78, *Factors that Influence Bal Seal® Performance* in our online technical library at www.balseal.com.

Recommended Shaft and Housing Tolerances*

Shaft Diameter Range in. (mm)	Recommended Tolerance			
	Shaft Dimension in. (mm)		Bore Dimension in. (mm)	
	Min.	Max.	Min.	Max.
0.060 to 0.999 (1.52 to 24.39)	-0.0005 (0.013)	+0.0000 (0.00)	-0.0000 (0.00)	+0.0005 (0.013)
1.000 to 1.999 (25.40 to 50.79)	-0.001 (-0.025)	+0.000 (0.00)	-0.000 (0.00)	+0.001 (0.025)
2.000 to 3.499 (50.80 to 88.99)	-0.0015 (-0.038)	+0.000 (0.00)	-0.000 (0.00)	+0.0015 (0.038)
3.500 to 5.999 (88.90 to 152.37)	-0.002 (-0.051)	+0.000 (0.00)	-0.000 (0.00)	+0.002 (0.051)
6.000 to 14.999 (152.40 to 380.97)	-0.003 (-0.076)	+0.000 (0.00)	-0.000 (0.00)	+0.003 (0.076)
15.000 to 19.999 (381.00 to 507.97)	-0.004 (-0.102)	+0.000 (0.00)	-0.000 (0.00)	+0.004 (0.102)
20.000 to 34.000 (508.00 to 863.00)	-0.005 (-0.127)	+0.000 (0.00)	-0.000 (0.00)	+0.005 (0.127)

Note: For "A" and "B" dimensions refer to pages 16, 17, 18 and 19.
For shaft and housing diameters above 34 in. (863 mm), please contact us.

*We manufacture seals to accommodate larger tolerances. Please contact us for more information.

Radial Clearance

The term “extrusion” describes the flowing of the seal ring material into the radial clearance “E” of the seal gland. This is caused by the media pressure acting on the seal’s internal cavity. Excessive extrusion can result in seal lip blowout and failure. The extrusion of the seal material increases as the pressure and/or radial clearance “E” increases. Extrusion can also be influenced by other factors, such as temperature and seal material. A backup ring should be used if the “E” clearance cannot be controlled as required. For more information, reference application bulletin PN-228, *Extrusion Lengths of Bal Seal® Materials Used in High-Pressure Service*, or technical report TR-94, *Factors Affecting PTFE Bal Seal® Performance*, in our online technical library at www.balseal.com.

Radial Clearance "E" (inches) @70 °F (21 °C)					
Cross Section Code	Pressure psi (bar)				
	150 (10)	300 (21)	500 (34)	1000 (69)	1500 (103)
2	0.001 (0.03)	0.001 (0.03)	0.001 (0.03)	0.001 (0.03)	0.001 (0.03)
1	0.002 (0.05)	0.002 (0.05)	0.002 (0.05)	0.002 (0.05)	0.002 (0.05)
0	0.004 (0.10)	0.003 (0.08)	0.003 (0.08)	0.003 (0.08)	0.003 (0.08)
4	0.005 (0.13)	0.004 (0.10)	0.004 (0.10)	0.003 (0.08)	0.003 (0.08)
5	0.006 (0.15)	0.005 (0.13)	0.005 (0.13)	0.004 (0.10)	0.004 (0.10)
6	0.007 (0.18)	0.006 (0.15)	0.005 (0.13)	0.0045 (0.11)	0.0045 (0.11)
7	0.008 (0.20)	0.007 (0.18)	0.006 (0.15)	0.0055 (0.14)	0.0055 (0.14)
8	0.010 (0.25)	0.008 (0.20)	0.007 (0.18)	0.0065 (0.17)	0.0065 (0.17)
9	0.012 (0.30)	0.010 (0.25)	0.008 (0.20)	0.0075 (0.19)	0.0075 (0.19)

Note: For cross section dimensions of various seal designs, refer to pages 16, 17, 18, and 19.



Dynamic Surface Hardness

A dynamic surface with a higher hardness will reduce adhesion of the seal ring material onto that surface, thereby reducing friction and consequently reducing premature seal wear. Some materials require elevated hardness to ensure longevity of the dynamic surfaces.

Surface Finish

The surface finish of the dynamic material has a significant effect on the seal performance. In general, the better the surface finish, the better the seal performance. A good surface finish results in better sealing ability, lower abrasive wear, lower frictional torque, and longer seal life. Small imperfections such as scratches, cutting tool marks, porosity, and eccentricities can create leakage paths (depending on the media type and pressure), and these should be minimized whenever possible. For more detail, reference Technical Report TR-4, *The Influence of Surface Finish on Bal Seal® Performance*, in our online technical library at www.balseal.com.

Suggested Surface Finishes

Media	Dynamic Surface		Static Surface	
	RMS	Ra $\mu\text{in.}$ (Ra μm)	RMS	Ra $\mu\text{in.}$ (Ra μm)
Cryogenes	2 to 4	1.8 to 3.6 (0.05 to 0.09)	4 to 8	3.6 to 7.2 (0.09 to 0.18)
Gases (air, nitrogen, oxygen, etc.)	4 to 8	5.4 to 10.8 (0.14 to 0.27)	12 to 32	10.8 to 28.8 (0.27 to 0.72)
Liquids (hydraulic fluid, water, etc.)	8 to 16	7.2 to 14.4 (0.18 to 0.36)	16 to 32	14.4 to 28.8 (0.36 to 0.72)

Dynamic Alignment

In order to achieve peak rotary seal performance, you must consider the dynamic alignment, or “eccentricity,” of your hardware. The two main components of dynamic alignment are shaft-to-bore misalignment (STBM) and runout (dynamic runout, or DRO). STBM, which can result from variations in machining or assembly, represents the measured offset between the centerline of the shaft and the centerline of the bore. Runout, which can be caused by misalignment, vibration, lobing, and other factors, describes the measured deviation of the shaft’s sealing surface from rotation around the true center. It is expressed in inches or millimeters as TIR, for “total indicator reading.” By taking steps to minimize STBM and runout, you can protect your designs from the effects of uneven seal contact, wear, and premature seal failure.

Shaft to Bore Misalignment at the Seal Area (STBM)

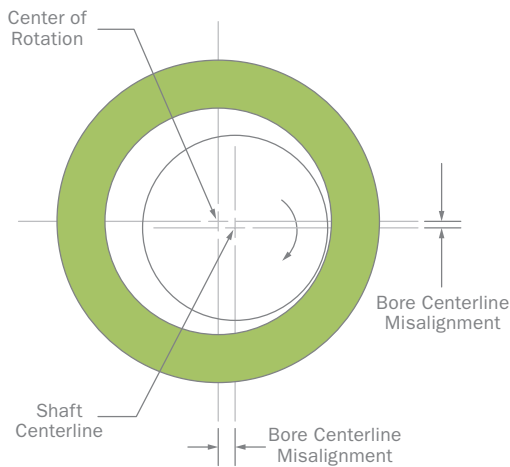

Shaft Diameter in. (mm)	Recommended Maximum STBM in. (mm)
0.000 to 0.750 (0.00 to 19.05)	0.002 (0.05)
0.751 to 1.500 (19.08 to 38.10)	0.0025 (0.064)
1.501 to 3.000 (38.13 to 76.20)	0.003 (0.08)
3.001 to 6.000 (76.23 to 152.40)	0.0035 (0.089)
6.001 to 10.000 (152.43 to 254.00)	0.0045 (0.114)

Allowable Runout (TIR) ¹ At Various Surface Speeds (FPM)					
Cross Section Code	TIR@50 FPM in. (mm)	TIR@500 FPM in. (mm)	TIR@1,000 FPM in. (mm)	TIR@2,500 FPM in. (mm)	TIR@5,000 FPM in. (mm)
1	0.0015 (0.038)	0.0010 (0.025)	0.0005 (0.013)	NR NR	NR NR
0	0.0025 (0.064)	0.0015 (0.038)	0.0010 (0.025)	0.0005 (0.013)	NR NR
4	0.0035 (0.089)	0.0025 (0.064)	0.0020 (0.051)	0.0010 (0.025)	NR NR
5	0.0045 (0.114)	0.0035 (0.089)	0.0030 (0.076)	0.0015 (0.038)	NR NR
6	0.0050 (0.127)	0.0040 (0.102)	0.0035 (0.089)	0.0020 (0.051)	NR NR
7	0.0060 (0.152)	0.0050 (0.127)	0.0045 (0.114)	0.0030 (0.076)	0.0020 (0.051)
8	0.0070 (0.178)	0.0060 (0.152)	0.0055 (0.140)	0.0040 (0.102)	0.0030 (0.076)
9	0.0075 (0.191)	0.0070 (0.178)	0.0065 (0.165)	0.0050 (0.127)	0.0040 (0.102)

Note: 1. Specified TIR is for spring-energized seals. 2. NR=Not Recommended. For more information and design assistance, please contact us. 3. For cross section dimensions of various seal designs, refer to pages 16, 17, 18, and 19.



Rotary Seal Installation Options

Assembling into a gland

Special tools are required to assemble a rotary seal into a gland with a sharp leading edge. The illustration below depicts a bore installation tool with a leading chamfer that protects the seal jacket material from the sharp edge. The seal is placed on a shaft installation tool that pushes the seal into place. Once assembled, both the bore installation tool and shaft installation tool are easily removed. We can provide recommendations on materials and dimensions to use for these installation tools. An arbor press is suggested to ensure assembly, and hard mechanical stopping points can help prevent seal damage. Light grease will also facilitate easier installation.

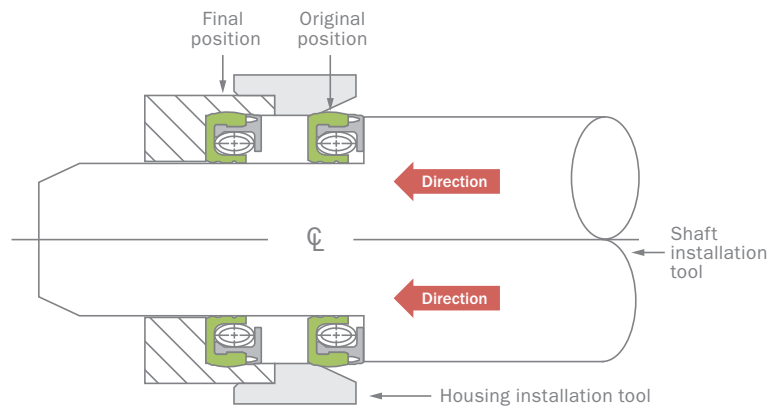

Assembly in gland with sharp entry corner

An open bore is a configuration in which the seal does not bottom out. Care must be taken to push the seal into the desired position. A recommended shaft installation tool is shown below. Note that the open bore must have an integral chamfered corner, because a sharp corner will damage the seal jacket material.

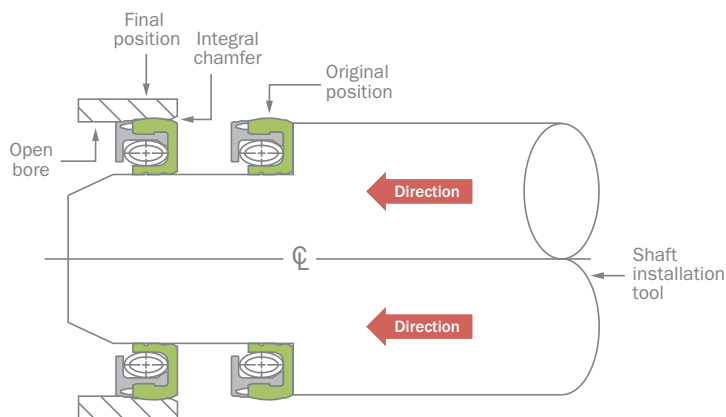

Assembly in open bore

Installing the shaft

The drawings below illustrate techniques for installing the shaft. In the first example, the shaft has a well chamfered lead-in, and can be installed without any special tools. The shaft is simply pushed slowly into the bore. In some cases, the shaft either has a very sharp corner, or is not self-centering. In these cases, we recommend a shaft installation tool designed to protect the seal during assembly. The installation tool is pushed into position, then the shaft is pushed into the installation tool and through the seal. The installation tool is removed when the shaft is correctly placed. Other specialized assembly methods are available. For more information, consult a technical representative, or reference TR-97, *Tools for Removing 'K' Series Rotary Bal Seals*, in our online technical library at www.balseal.com.

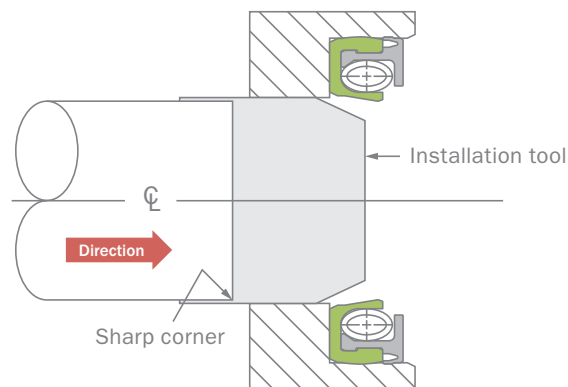
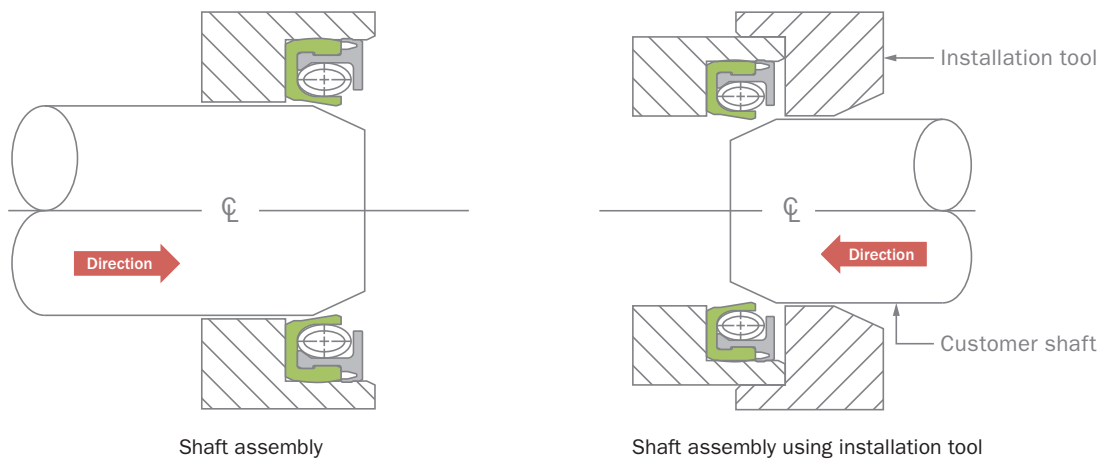

Assembly of shaft from forward direction



Rotary Seal Application Example

Designers across a broad range of industries, from medical and analytical to aerospace, defense, and transportation, rely on the Bal Seal® spring-energized rotary seal to improve the performance and reliability of their products. By enabling you to control frictional values and other important properties with pinpoint precision, our custom-engineered seal gives you the ability to tackle tough speed, temperature, pressure, and media challenges like no off-the-shelf solution can.

High-speed Dental Drill

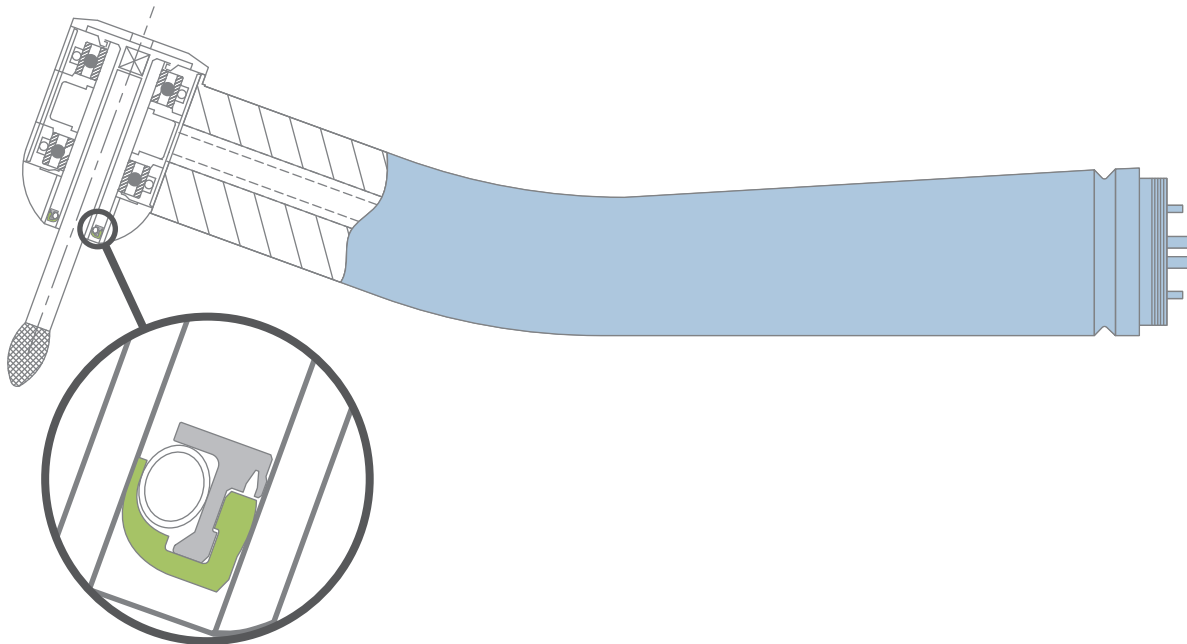

Bal Seal® KTS Series Seal

Operating Parameters	
Pressure	Atmospheric to 15 psi (1 bar)
Media	Bone, tissue, bearing grease, and sterilization fluids
Speed	50–300 ft/min (0.25–1.5 m/s)
Temperature	70 °F (21 °C) operating; 250 °F (121 °C) autoclave cleaning

Sealing Successes

As an experienced seal designer and manufacturer, we take a holistic approach to solving your rotary sealing challenges. We consider the hardware, seal material, energizer, and jacket geometry—but we also study your overall performance requirements, and recommend new features or configurations that can offer major performance advantages. Below are some examples of how we've combined design expertise and decades of sealing know-how to create innovative solutions that are far from typical.

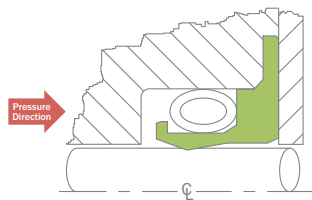

Cryogenic Seal,
Medium-speed, Very Low Pressure

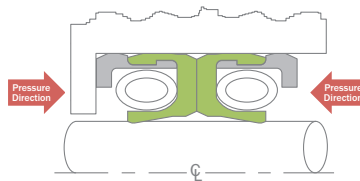

Bi-directional Seal
Medium-speed, Low-pressure

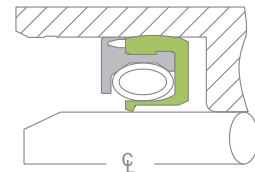

High-speed Seal

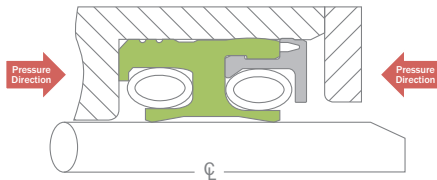

Bi-directional Seal
Low-speed, Low-pressure

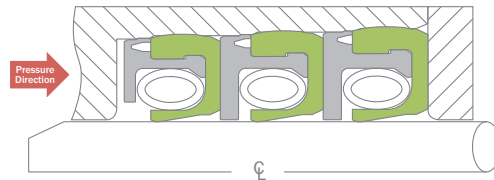

Multi-sealing, Medium-speed, Medium-pressure

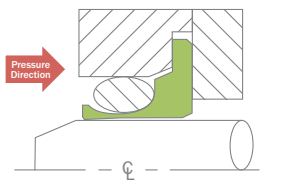

Sealing, Medium-speed, Medium-pressure

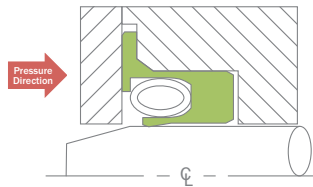

Front-flanged, High-speed,
Medium-pressure Seal

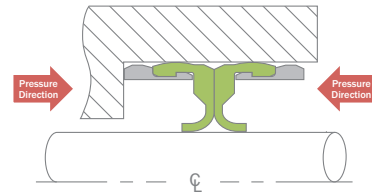

Multi-sealing, High-speed, Low-pressure Seal

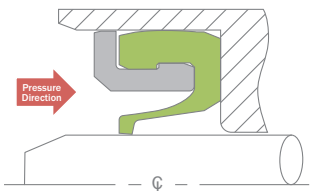

High-speed Seal

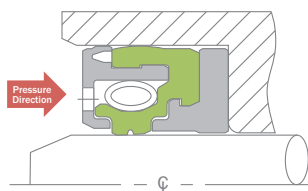

Anti-blowout Seal

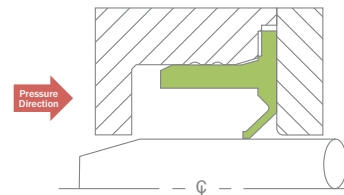

High-speed Flanged Seal

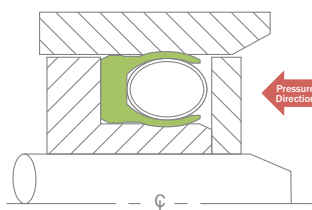

Cryogenic Seal for Low-speed
with Ribbon Spring

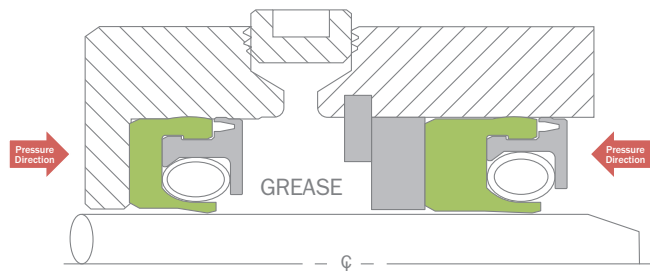

Seal for Medium-speed
Low Differential Pressures



Design Request Form—Rotary Seals

In order to design your Bal Seal® Rotary Sealing Solution, we need to know more about your application requirements. Please complete this form and e-mail it to us at sales@balseal.com, or fax it to (949) 460-2300.

Name		Date	
Company		Title	
Address		Department	
City, State & Zip		Telephone	
E-mail		Fax	
Product data		Service	
Equipment type		<input type="checkbox"/> Continuous <input type="checkbox"/> Intermittent <input type="checkbox"/> Oscillating <input type="checkbox"/> Other	
Application is used for <input type="checkbox"/> Prototype <input type="checkbox"/> Production <input type="checkbox"/> Retrofit <input type="checkbox"/> Other		Speed	
Annual usage		<input type="checkbox"/> fpm <input type="checkbox"/> cpm <input type="checkbox"/> rpm <input type="checkbox"/> m/s	
Target price (per unit)			
Description of current solution:			
Critical factors		Temperature	
	Value	Assign order of priority, 1 (highest) to 5 (lowest)	Minimum <input type="checkbox"/> °C <input type="checkbox"/> °F <input type="checkbox"/> °K
Friction			Operating <input type="checkbox"/> °C <input type="checkbox"/> °F <input type="checkbox"/> °K
Service life			Maximum <input type="checkbox"/> °C <input type="checkbox"/> °F <input type="checkbox"/> °K
Sealing performance			Does seal reach operating temperature before pressure is applied? <input type="checkbox"/> Yes <input type="checkbox"/> No
Compatibility			Does seal reach cold temperatures prior to pressurizing? <input type="checkbox"/> Yes <input type="checkbox"/> No
Cost			What is maximum temperature that maximum pressure will see?
Media type (Please select all that apply)		Pressure	
<input type="checkbox"/> Gas <input type="checkbox"/> Abrasives <input type="checkbox"/> Contaminant <input type="checkbox"/> Liquid <input type="checkbox"/> Solid particles (size=) <input type="checkbox"/> Other <input type="checkbox"/> Viscous <input type="checkbox"/> Corrosive		<input type="checkbox"/> psi <input type="checkbox"/> MPa <input type="checkbox"/> kg/cm ² <input type="checkbox"/> bar	
Specific gravity	Relative humidity	Minimum <input type="checkbox"/> °C <input type="checkbox"/> °F <input type="checkbox"/> °K	
Volatiles	Viscosity <input type="checkbox"/> cP <input type="checkbox"/> cSt	Operating <input type="checkbox"/> °C <input type="checkbox"/> °F <input type="checkbox"/> °K	
Torque		Maximum <input type="checkbox"/> °C <input type="checkbox"/> °F <input type="checkbox"/> °K	
<input type="checkbox"/> lbs. <input type="checkbox"/> N		Reverse:	
Breakout	Running	Cycling (+/-):	
Dimensional information		Vacuum	
	<input type="checkbox"/> Inches <input type="checkbox"/> mm	Tolerance (+/-)	<input type="checkbox"/> in Hg <input type="checkbox"/> Pa <input type="checkbox"/> Torr
		Can be modified	
Shaft diameter (A)		<input type="checkbox"/>	Material
Bore diameter (B)		<input type="checkbox"/>	Plating/coating
Gland length (C)		<input type="checkbox"/>	Hardness (Rc)
Gland height (D)		<input type="checkbox"/>	Surface finish <input type="checkbox"/> RMS <input type="checkbox"/> Ra
Radial shaft/bore clearance (E)		<input type="checkbox"/>	Shaft information
Eccentricity		Material	
TIR:	STBM:	Plating/coating	
		Hardness (Rc)	
		Surface finish <input type="checkbox"/> RMS <input type="checkbox"/> Ra	
Gland configurations			
<input type="checkbox"/> Uncaptivated seal gland:		<input type="checkbox"/> Captivated seal gland:	
<input type="checkbox"/> Flanged:			
Can you supply shaft/bore/gland drawings? <input type="checkbox"/> Yes <input type="checkbox"/> No			

www.balseal.com

Important Information

CLEANING

Bal Seal Engineering products may require cleaning and/or sterilization before use, depending on the application.

TESTING

It is essential that the customer run evaluation tests to determine if the proposed, supplied, or purchased Bal Seal Engineering products are suitable for the intended purpose. Tests should be run under actual service conditions with an adequate safety factor.

Welded springs have an increased probability of breaking or failing at or near the weld. This probability is magnified if the spring is used in an application involving extension of the spring. In addition, temperature affects the properties of the spring (i.e., tensile strength, elongation, etc.) Failure of Bal Seal Engineering products can cause equipment failure, property damage, personal injury, or death. Equipment containing Bal Seal Engineering products must be designed to provide for any eventuality that may result from a partial or total failure of Bal Seal Engineering products.

Bal Seal Engineering products must be tested with a sufficient safety factor after installation and they must be subjected to a program of regular maintenance and inspection. The customer, through analysis and testing, is solely responsible for making the final selection of the products and for ensuring that all performance, safety, and other requirements of the application are met.

All information and recommendations contained herein are based on tests Bal Seal Engineering believes to be reliable, but the accuracy or completeness is not guaranteed. Any such information or recommendation is given solely for purposes of illustration and is not to be construed as a warranty that any goods will conform to such information or recommendation. No one, including Bal Seal Engineering employees, salespersons, representatives, wholesalers, or distributors is authorized to make any warranty or representation, and no customer or other user may rely on any such warranty or representation. Bal Seal Engineering reserves the right to make any changes to its products and to the contents of this document (such as dimensional data, force, torque, materials, pressures, temperatures, surface finishes, surface speed, etc.) without notice.

Nothing contained herein or in any of Bal Seal Engineering's literature constitutes a license or recommendation to use any process, or to manufacture, or to use any product in conflict with existing or future patents covering any product material or its use.

DISCLAIMER OF ALL WARRANTIES

The implied warranties of merchantability and fitness for a particular purpose and all other implied warranties are expressly disclaimed. There are no express warranties, except those, if any, specifically enumerated in this document (LE-173).

LIMITATION OF LIABILITY/REMEDIES

The liability of Bal Seal Engineering, whether as a result of breach of any warranty, failure to provide timely delivery of products, product malfunction, negligence or otherwise, shall be limited to repairing or replacing the non-conforming products or any part thereof, or, at Bal Seal Engineering's option, to the repayment to the customer all sums paid by the customer upon return to Bal Seal Engineering of the non-conforming products or part thereof. It is expressly agreed that the customer's remedy, as stated above, shall be exclusive and that under no circumstances shall Bal Seal Engineering be liable for any other damages, including direct, indirect, incidental, or consequential damages (LE-173).

PATENTS

The products described herein include those which are the subject of pending and issued patents, both foreign and domestic, including patents 6,641,141; 7,210,398; 10,184,564; 8,328,202; 9,194,497; 20,180,119,857; 20170,328,474 (LE-173).

Copyright 2019, Bal Seal Engineering, Inc.
(621-5-11)

We're more than just a component maker. In early development or existing product improvement stages, we combine our proven seals, springs, and electrical contacts with engineering, material science, and precision manufacturing expertise to produce solutions that break down performance barriers.



Americas*

Bal Seal Engineering, Inc.
19650 Pauling, Foothill Ranch, CA 92610-2610
Telephone +1 949 460 2100 or Toll Free +1 800 366 1006
Fax +1 949 460 2300

Europe, Middle East, Africa

Bal Seal Engineering Europe B.V.
Jollemanhof 16, 5th floor, 1019 GW Amsterdam
The Netherlands
Telephone +31 20 638 6523
Fax +31 20 625 6018

Asia Pacific

Bal Seal Asia Limited
Suite 901, Chinachem Century Tower
178 Gloucester Road, Wanchai, Hong Kong
Telephone +852 28681860
Fax +852 22956753

*Registered manufacturing facilities in California and Colorado enable us to ensure on-time product delivery, and help you mitigate risk.



www.balseal.com sales@balseal.com

Custom components that drive tomorrow's technologies.®