



**Bal Seal® Spring-Energized Seal
Solutions for Reciprocating and
Static/Face Applications**

Custom components that drive tomorrow's technologies.®



Contents

2	Innovation Through Engineering Collaboration
3	Bal Seal® Design Features and Benefits
4	Bal Seal® Spring-Energized Reciprocating and Static/Face Seal Designs
5	Bal Seal® Spring-Energized Seal Materials
6	Bal Spring® Canted Coil Spring Energizers
8	Bal Seal® Reciprocating Seals
12	Design Parameters
15	Assembly and Installation Configurations
17	Guide Rings
18	Bal Seal® Static/Face Seals
22	Typical Bal Seal® Spring-Energized Seal Applications
24	Customized Solution Examples
26	Design Request Form—Reciprocating/Radial Seals
27	Design Request Form—Static/Face Seals
28	Important Information



Innovation Through Engineering Collaboration

Bal Seal Engineering, Inc. is a global provider of custom-engineered sealing, connecting, conducting, and EMI/RFI shielding solutions.



We're more than just a problem-solver, we're your innovation partner. With over half a century of experience and a vast application knowledge base, we specialize in helping OEMs develop breakthroughs that shape industry standards, push the technology envelope, and provide a competitive edge.

Whether you're addressing an existing challenge or in the early stages of development, we can help. Our engineers have the skills and expertise to collaborate and contribute during every step of the process, and get your product to market faster.

Our core technology, the Bal Spring[®] canted coil spring, is a versatile component that functions independently or in combination with precision polymer sealing and metal retaining elements to enhance the performance and reliability of critical equipment used everywhere, from deep sea to deep space, and everywhere in between.

Bal Seal® Design Features and Benefits

We offer a broad range of Bal Seal® spring-energized seal types for reciprocating and static/face applications. The following pages contain examples of typical configurations, cross sections, and size ranges. Contact us with your specific application requirements, and we'll custom-engineer a solution that will increase the performance, safety, and reliability of your products.

Dynamic Wiper Lip

Series 13 for Housing Mounting/Series 14 for Piston Mounting

Features a short dynamic sealing lip, which improves overall seal performance.

- Improved sealing ability
- Better wiping
- Reduced friction
- Reduced heat buildup for longer life

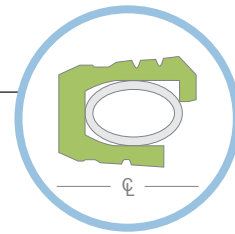

Metal Retaining Ring

Series KS13

A self-retaining seal with metal-to-metal contact between housing material and metal locking ring.

- Good retention
- Suitable for high and low temperatures
- Greater thermal stability

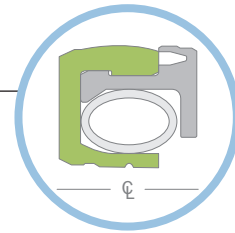

Flanged Seal

Series R13

Provides secondary sealing on the flange.

- Well suited for cryogenic applications
- Long-term sealing applications
- Reduces seal shuttling

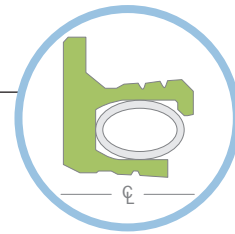

High-Pressure Seal

Series UN13, UN14, UN15

High-pressure reciprocating service.

- Excellent sealing ability
- Extended heel zone for increased seal strength
- Better resistance to extrusion
- Improved stability/performance at high temperatures and pressures

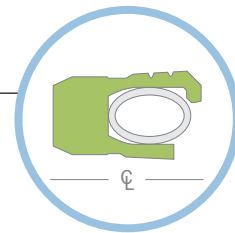

Face Seal (Static)

Series S2 for Internal Pressure/Series IS2 for External Pressure

Radial-shaped sealing lips promote better sealing ability.



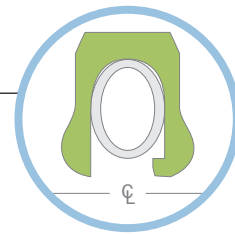



- Suitable for cryogenic applications
- Suitable for oscillatory and slow rotary applications





Bal Seal® Spring-Energized Reciprocating and Static/Face Seal Designs

The table below contains a small sampling of the hundreds of profiles we've designed. Seal jacket geometries and energizer properties can be precisely engineered to meet unique application requirements.

Seal Design	Series	Features/Applications	Pressure Limit ¹ psi (bar)	Cross Section Range in. (mm)	Inside Diameter Range in. (mm)
	13	Wiping, low friction, longer life.	3000 (207)	0.031 to 0.500 (0.8 to 12.7)	0.062 to 120 (1.6 to 3048)
	P14	One-piece pistons with 1/4 step. Better seal retention into groove.	3000 (207)	0.062 to 0.187 (1.6 to 4.7)	0.312 to 1.875 (7.9 to 47.6)
	15	Symmetrical design for piston or rod sealing.	3000 (207)	0.031 to 0.500 (0.8 to 12.7)	0.062 to 120 (1.6 to 3048)
	CC13	Very small diameters and small cross sections.	2000 (138)	0.016 to 0.062 (0.4 to 1.6)	0.016 to 0.093 (0.4 to 2.4)
	KS13	For thermal cycling and self-retaining with a metal locking ring. High and low temperatures.	3000 (207)	0.044 to 0.585 (1.1 to 14.8)	0.125 to 34 (3.2 to 863)
	R13	Flange-mounted. Reduces seal movement. Low friction, longer life.	3000 (207)	0.031 to 0.500 (0.8 to 12.7)	0.062 to 120 (1.6 to 3048)
	UN13	For high pressure, low friction.	10000 (689)	0.031 to 0.500 (0.8 to 12.7)	0.062 to 120 (1.6 to 3048)
	PW	Spring-energized guide ring for better piston guidance and alignment.	NA	0.031 to 0.500 (0.8 to 12.7)	0.062 to 120 (1.6 to 3048)
	64	Low dead volume. Excellent chemical compatibility. Vacuum to low pressure. Snap-on assembly. Seal permanently locks onto piston.	60 (4)	0.031 to 0.125 (0.8 to 3.2)	OD Range 0.063 and up (1.6 and up)
	S15	For use in internal pressure conditions and slow rotary applications.	3000 (207)	0.062 to 0.250 (1.6 to 6.4)	0.188 to 120 (4.8 to 3048)
	S2	Face seal for static sealing and slow rotary applications.	3000 (207)	0.062 to 0.250 (1.6 to 6.4)	0.188 to 120 (4.8 to 3048)

1. Pressure limits are based on UHMWPE. PTFE material pressure limits will be lower.

Bal Seal® Spring-Energized Seal Materials

	Material/Description	Material Temperature Range °F (°C)	Wear Resistance 5=Excellent 1=Fair	Pressure/Extrusion Resistance 5=Excellent 1=Fair	Abrasion to Shaft
Polytetrafluoroethylene	T (Virgin PTFE) Light-duty service. Lowest friction. Excellent chemical compatibility. FDA compliant. Color: White	-450 to 450 (-270 to 230)	1	1	Low
	TA (PTFE—LOW PERMEABILITY/DEFORMATION) Superior mechanical properties with good surface finishes. Good sealing ability in gases and vacuum. Suitable for semiconductor applications. FDA Compliant. Color: White	-450 to 450 (-270 to 230)	2	2	Low
	G (GRAPHITE-FILLED PTFE) Light-duty service. Low friction. Very good chemical compatibility. Good wear resistance in liquids, humid conditions. Color: Black	-450 to 475 (-270 to 230)	2	2	Low
	GC (GRAPHITE-CARBON-FILLED PTFE) General light duty. Low friction. Very good chemical compatibility. Good wear resistance in liquids, humid conditions. Color: Black	-450 to 500 (-270 to 230)	3	3	Low
	GFP55 (GRAPHITE-FIBER-REINFORCED PTFE) Severe service conditions. Excellent performance in applications with high pressure, low speed, and high temperature. Color: Black	-450 to 500 (-270 to 260)	4	5	Medium
	GFP (GRAPHITE-FIBER-REINFORCED PTFE) Severe service conditions. Excellent performance in applications with high pressure, low speed, and high temperature. Color: Black	-450 to 500 (-270 to 260)	5	5	Medium
	GFBM55 HT (MoS ₂ -REINFORCED PTFE) Severe dry and liquid service. Excellent wear and extrusion resistance in liquids, inert gases, vacuum. Color: Black	-450 to 500 (-270 to 260)	4	5	Medium
	GLMO4 (GLASS-MOLY-FILLED PTFE) For severe conditions, excellent extrusion resistance. May be abrasive to soft mating materials. Color: Black	-450 to 500 (-270 to 260)	5	5	High
	GL20 (GLASS-FILLED PTFE) Severe dry/vacuum service. Excellent wear and extrusion resistance and low outgassing. Color: Off-white	-450 to 500 (-270 to 260)	5	5	High
	SP45 (POLYMER-FILLED PTFE) General-purpose material designed for contact with housings and pistons made of soft metals or plastics. Good for high-speed, low-pressure applications. Color: Light gray/green	-450 to 500 (-270 to 260)	5	4	Low
SP191 (POLYMER-FILLED PTFE) Gas compressor systems and oxygen intensifier systems applications. Excellent wear resistance in various gases. Low abrasion to dynamic surfaces and operates well against soft mating surfaces like aluminum, mild steel, brass, and plastics. FDA compliant. Color: Tan	-400 to 550 (-240 to 287)	5	4	Low	
Polyethylene	UPC10 (POLYETHYLENE) Aqueous service. Good wear and extrusion resistance in aqueous media. For general service. FDA compliant. Color: Translucent white	-450 to 180 (-270 to 80)	4 (aqueous solutions)	5	Low
	UPC16 (POLYETHYLENE) High purity, high wear resistance in water and aqueous solutions. FDA compliant. Color: Translucent white	-450 to 180 (-270 to 80)	4 (aqueous solutions)	5	Low
	UP30 (UHMW POLYETHYLENE BLEND) Suitable for very high-pressure low-speed reciprocating applications such as HPLC and cryogenic applications. FDA compatible. Color: Gold	-450 to 180 (-270 to 80)	4 (aqueous solutions)	5	Low
PEEK	P41 HT (HIGH-PERFORMANCE POLYMERS) High-performance materials for high-temperature service. FDA compatible. Color: Beige.	-70 to 600 (-60 to 316)	5	5	Medium

Bal Seal Engineering defines "FDA Compliant" as materials that have been found by the FDA to be "safe for use in food contact" or "acceptable for use in food contact." "FDA Compatible" is defined by Bal Seal Engineering as compositions where FDA has deemed the majority (97% or more) of the ingredients "safe for use in food contact" and they contain no ingredient listed in the California Code of Regulations Hazardous Substance List.

It is essential that the customer run evaluation testing under actual service conditions with a sufficient safety factor to determine if the proposed, supplied or purchased Bal Seal Engineering, Inc. products are suitable for the intended purpose and to confirm expected results. Bal Seal Engineering, Inc. shall not be liable for any loss or damage of any kind or nature that may result from the use of, reference to, or reliance on the information contained herein, including but not limited to consequential, special (including loss of profits) direct, indirect, incidental or similar damages, even if Bal Seal Engineering, Inc. has been advised of the possibility of such damages. Products described herein may be covered all or in part by various existing and/or pending U.S. patents.



Bal Spring® Canted Coil Spring Energizers



Bal Seal Engineering is the original developer of the Bal Spring® canted coil spring as a seal energizer. Our innovative design holds the spring force nearly constant over a wide deflection range. As the seal jacket wears, the spring continues to provide the same sealing force. Spring loads are customizable, enabling you to optimize friction, sealing, and performance life.



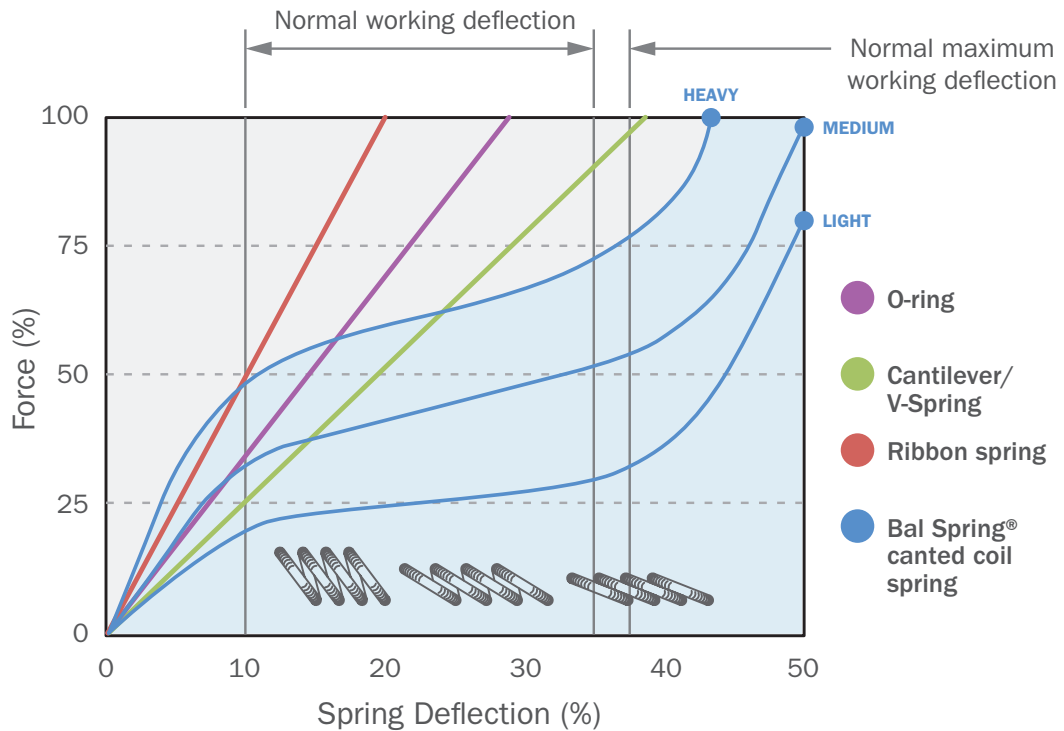

Force Deflection Chart

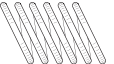

Bal Spring® Canted Coil Spring Energizer Materials

Material	Advantages	Limitations	Typical Applications
BSE1 or BSE2 (Stainless Steel)	<ul style="list-style-type: none"> Low cost and readily available Highest tensile strength of all standard Bal Spring® materials 	<ul style="list-style-type: none"> Lower corrosion resistance than BSE3 or BSE 4 and BSE5 Mechanical properties change at elevated temperatures 	<ul style="list-style-type: none"> General service
BSE3 or BSE4 (Stainless Steel)	<ul style="list-style-type: none"> Better corrosion resistance than BSE1 or BSE2 due to higher nickel and molybdenum content 	<ul style="list-style-type: none"> Mechanical properties lower than BSE1 or BSE2 	<ul style="list-style-type: none"> Biomedical Food processing
BSE5 (Stainless Steel)	<ul style="list-style-type: none"> Higher corrosion resistance than BSE3 or BSE4 due to lower carbon content 	<ul style="list-style-type: none"> Higher cost than BSE3 or BSE4 	<ul style="list-style-type: none"> Biomedical Corrosive environments Laboratory Food processing
BSE9 (Beryllium Copper Alloy)	<ul style="list-style-type: none"> High-strength copper alloy 	<ul style="list-style-type: none"> Limited temperature range 	<ul style="list-style-type: none"> Parts requiring good electrical conductivity EMI shielding Electronics
BSE17 (Nickel Alloy)	<ul style="list-style-type: none"> Higher corrosion resistance and operating temperature than BSE1 or BSE2, BSE3 or BSE4, and BSE5 stainless steels 	<ul style="list-style-type: none"> Limited availability 	<ul style="list-style-type: none"> Corrosive environments
BSE18 (Nickel Alloy)	<ul style="list-style-type: none"> High resistance to stress cracking High corrosion resistance Resistant to cracking under NACE Level VII conditions Compatible with hydrogen sulfide 	<ul style="list-style-type: none"> Wire size 	<ul style="list-style-type: none"> Petrochemical applications with hydrogen sulfide sour gas per NACE report MR-01-75
BSE19 (Cobalt Nickel Alloy)	<ul style="list-style-type: none"> Compatible with hydrogen sulfide Nickel-based material with higher modulus of elasticity than all other stainless steel materials with higher mechanical properties than other stainless steel materials 	<ul style="list-style-type: none"> Galvanic corrosion can occur when coupled with dissimilar metals 	<ul style="list-style-type: none"> Body implant applications such as pacemakers Petrochemical applications where corrosion resistance to hydrogen sulfide is necessary
BSE28 (Titanium Alloy)	<ul style="list-style-type: none"> Commonly used, heat treatable with good stiffness and thermal properties Excellent combination of strength and corrosion resistance 	<ul style="list-style-type: none"> Non-medical grade alloy High cost 	<ul style="list-style-type: none"> Military, aircraft, spacecraft Medical devices Connecting rods for sports cars Some sports equipment

Energizer Types

Energizer	Type	Friction	Sealing	Wear	High Speed	Vacuum Gas	High Pressure	Cryogenic
	Light	Low	Low	Low	Excellent	Not Recommended	Good	Poor
	Medium	Moderate	Moderate	Moderate	Good	Fair	Excellent	Fair
	Heavy	High	High	High	Not Recommended	Good	Excellent	Good
	Cantilever/ V-Spring	High	High	Moderate	Not Recommended	Excellent	Excellent	Good
	O-Ring	High	High	High	Not Recommended	Excellent	Fair	Fair



Bal Seal® Reciprocating Seals

Cross sections range from 0.016 to 0.500 in. (0.40 to 12.70 mm). Seal cross sections and seal inside diameters are divided into available and suggested size ranges. Suggested sizes will generally result in optimal seal performance.

Suggested Standard Bal Seal® Cross Sections and Seal Inside Diameters

Cross Section		Nominal Cross Section in. (mm)	Seal Inside Diameter			
			Available Sizes	Suggested Sizes		Available Sizes
Code	Size		Min. in. (mm)	Min. in. (mm)	Max. in. (mm)	Max. in. (mm)
2	1/64	0.016 (0.40)	0.016 (0.40)	0.031 (0.79)	0.040 (1.02)	0.062 (1.57)
1	1/32	0.031 (0.79)	0.025 (0.64)	0.041 (1.04)	0.312 (7.93)	0.68 (17.45)
0	1/16	0.062 (1.57)	0.050 (1.27)	0.187 (4.75)	0.750 (19.05)	2.50 (63.50)
4	3/32	0.094 (2.38)	0.094 (2.39)	0.500 (12.70)	1.500 (38.10)	4.00 (101.60)
5	1/8	0.125 (3.18)	0.187 (4.75)	1.000 (25.40)	2.500 (63.50)	9.00 (228.60)
6	3/16	0.187 (4.75)	0.500 (12.70)	1.500 (38.10)	4.000 (101.60)	12.50 (317.50)
7	1/4	0.250 (6.35)	1.500 (38.10)	2.000 (50.80)	8.000 (203.20)	18.00 (457.20)
8	3/8	0.375 (9.53)	As requested	2.500 (63.50)	15.000 (381.00)	30.00 (762.00)
9	1/2	0.500 (12.70)	As requested	3.500 (88.90)	24.000 (609.60)	75.00 (1905.00)

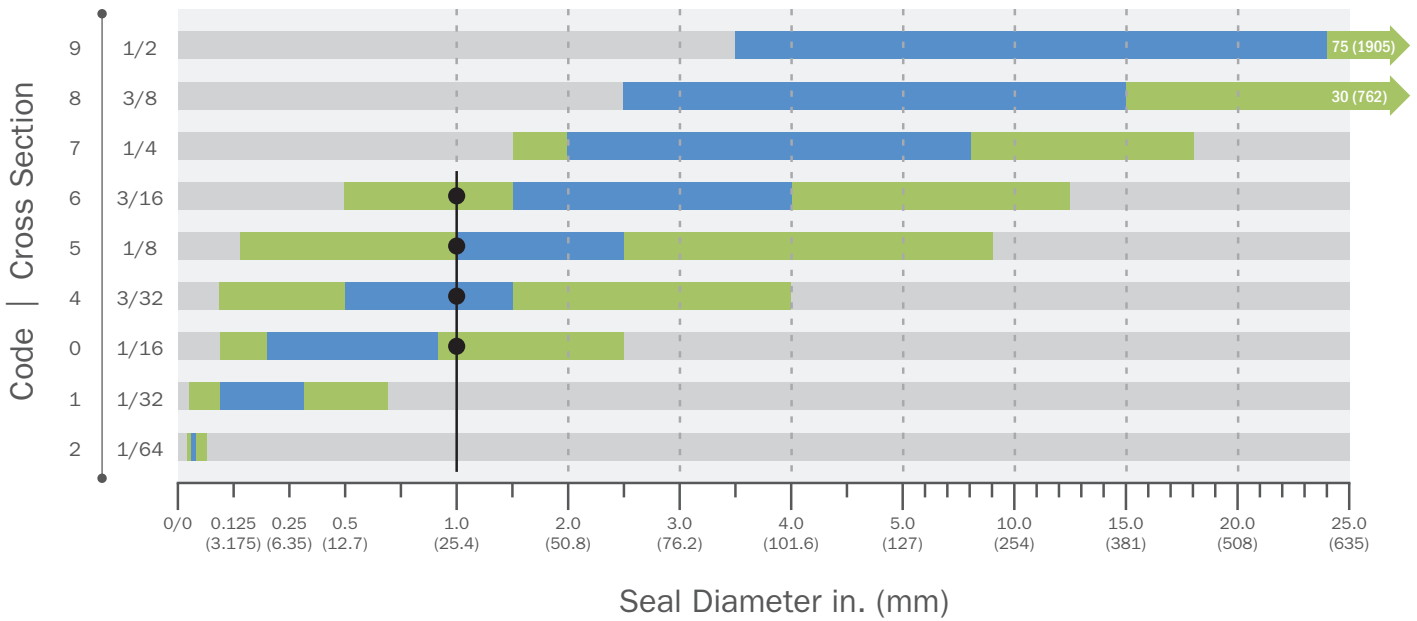

● Suggested diameter range ● Available diameter range

Example: A 1.0 in. seal diameter is available in cross sections 1/16, 3/32, 1/8, and 3/16 in.

Bal Seal® Large Diameter Spring-Energized Seals

Our Bal Seal® spring-energized large diameter seals offer big performance advantages in critical equipment. Designed to handle slow-speed rotary and reciprocating applications, our one-piece seals provide OEM designers and end users with excellent resistance to wear, extrusion and chemicals—all of which translates into more uptime and profitability. Our low-friction seals are energized with a Bal Spring® canted coil spring, which promotes even wear and prolongs service life. Seals are available in select profiles and a variety of materials.



Our seals are available in diameters to suit applications from the very small to the very large.



Reciprocating Seal Gland Dimensions

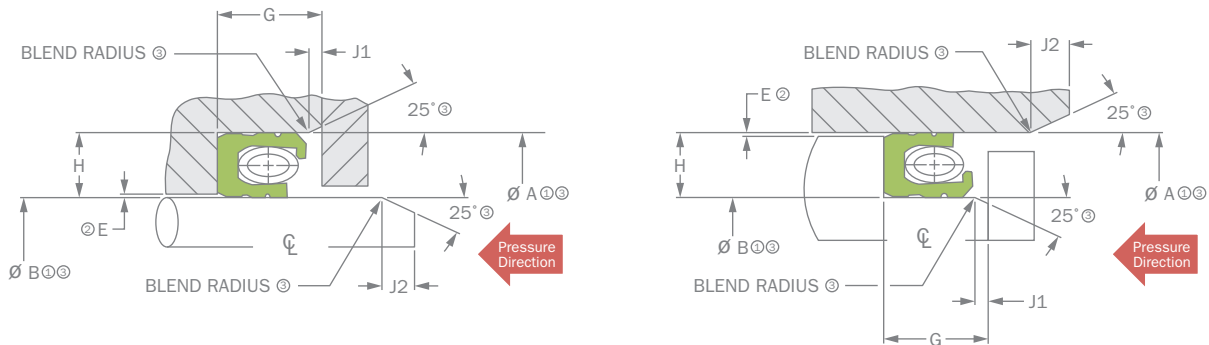

① See page 15 for gland diameters for stepped grooves of common seal sizes. ② Radial clearance determined by service conditions (a recommended radial clearance is shown on Bal Seal Engineering design proposal drawings; refer to page 13 for radial clearance dimension). ③ Refer to page 14 for recommended surface finishes. For KS13 and 64 series gland dimensions, contact us to discuss your specific application requirements.

Cross Section		H Nominal Gland Height in. (mm)	G Gland Length in. (mm)		Chamfer Length in. (mm)	
Code	Size		Standard Seals	U Series Seals	J1	J2
2	1/64	0.016 (0.40)	0.029/0.034 (0.74/0.86)	0.055/0.058 (1.40/1.47)	0.005±0.001 (0.13±0.03)	0.015±0.003 (0.38±0.08)
1	1/32	0.031 (0.79)	0.053/0.058 (1.34/1.47)	0.071/0.076 (1.80/1.93)	0.007±0.001 (0.18±0.03)	0.031±0.004 (0.79±0.10)
0	1/16	0.062 (1.57)	0.098/0.103 (2.49/2.62)	0.120/0.125 (3.05/3.18)	0.010±0.002 (0.25±0.05)	0.062±0.005 (1.57±0.13)
4	3/32	0.094 (2.38)	0.144/0.154 (3.66/3.91)	0.183/0.193 (4.65/4.90)	0.015±0.003 (0.38±0.08)	0.093±0.006 (2.36±0.15)
5	1/8	0.125 (3.18)	0.183/0.193 (4.65/4.90)	0.263/0.273 (6.68/6.93)	0.020±0.003 (0.58±0.08)	0.125±0.008 (3.17±0.20)
6	3/16	0.187 (4.75)	0.263/0.273 (6.68/6.93)	0.351/0.366 (8.92/9.30)	0.025±0.003 (0.64±0.08)	0.187±0.010 (4.75±0.25)
7	1/4	0.250 (6.35)	0.351/0.366 (8.92/9.30)	0.523/0.543 (13.28/13.79)	0.035±0.003 (0.89±0.08)	0.250±0.012 (6.35±0.30)
8	3/8	0.375 (9.35)	0.523/0.543 (13.28/13.79)	0.686/0.711 (17.42/18.06)	0.045±0.004 (1.14±0.10)	0.375±0.015 (9.53±0.38)
9	1/2	0.500 (12.70)	0.686/0.711 (17.42/18.06)	0.911/0.931 (23.13/23.65)	0.060±0.006 (1.52±0.15)	0.500±0.020 (12.7±0.51)

Solutions for Reciprocating and Static/Face Applications

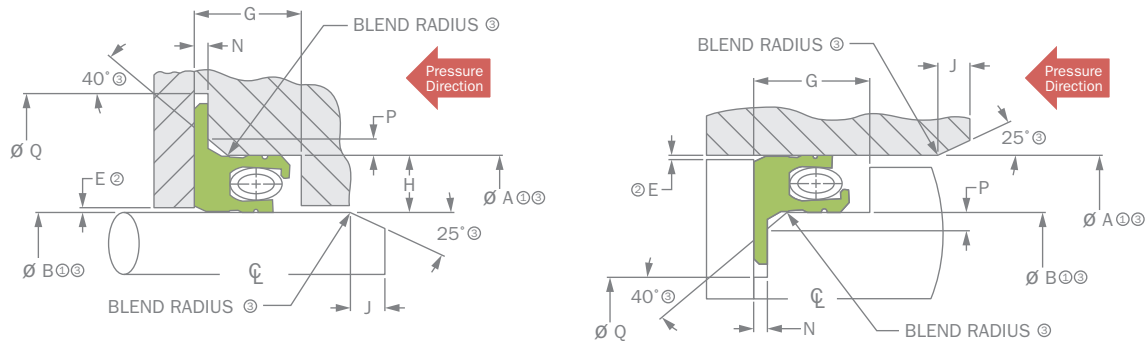

①Radial clearance varies with service conditions. ②A recommended radial clearance is shown on Bal Seal design proposal drawings. ③Refer to page 13 for recommended radial clearance.

Cross Section		H Nominal Gland Height in. (mm)	G Gland Length in. (mm)		N Flange Depth in. (mm)	P Chamfer Height in. (mm)	Chamfer Length in. (mm)		J Chamfer Length in. (mm)
Code	Size		R/IR Series Seals	UR/UIR Series Seals			R/UR Series Seals +xxx/-0	IR/UIR Series Seals +0/-xxx	
1	1/32	0.031 (0.79)	0.075/0.095 (1.91/2.41)	0.092/0.112 (2.34/2.84)	0.012/0.013 (0.30/0.33)	0.012/0.017 (0.30/0.43)	A +0.096 (2.44)	B -0.096 (-2.44)	0.031±0.004 (0.79±0.10)
0	1/16	0.062 (1.57)	0.117/0.137 (2.97/3.48)	0.138/0.158 (3.51/4.01)	0.012/0.013 (0.30/0.33)	0.017/0.023 (0.43/0.58)	A +0.135 (3.43)	B -0.135 (-3.43)	0.062±0.005 (1.57±0.13)
4	3/32	0.094 (2.39)	0.171/0.191 (4.34/4.85)	0.203/0.223 (5.16/5.66)	0.019/0.020 (0.48/0.51)	0.028/0.035 (0.71/0.89)	A +0.143 (3.63)	B -0.143 (-3.63)	0.093±0.006 (2.36±0.15)
5	1/8	0.125 (3.18)	0.220/0.240 (5.59/6.10)	0.259/0.279 (6.58/7.09)	0.026/0.027 (0.66/0.69)	0.040/0.049 (1.02/1.24)	A +0.155 (3.94)	B -0.155 (-3.94)	0.125±0.008 (3.17±0.20)
6	3/16	0.187 (4.75)	0.280/0.300 (7.11/7.62)	0.351/0.371 (8.92/9.42)	0.031/0.032 (0.79/0.81)	0.057/0.067 (1.45/1.70)	A +0.246 (6.25)	B -0.246 (-6.25)	0.187±0.010 (4.75±0.25)
7	1/4	0.250 (6.35)	0.375/0.395 (9.53/10.03)	0.489/0.509 (12.42/12.93)	0.044/0.045 (1.12/1.14)	0.069/0.080 (1.75/2.03)	A +0.306 (7.77)	B -0.306 (-7.77)	0.250±0.012 (6.35±0.30)
8	3/8	0.375 (9.53)	0.565/0.585 (14.35/14.86)	0.741/0.761 (18.82/19.33)	0.088/0.090 (2.24/2.29)	0.080/0.092 (2.03/2.34)	A +0.384 (9.75)	B -0.384 (-9.75)	0.375±0.015 (9.53±0.38)
9	1/2	0.500 (12.70)	0.743/0.763 (18.87/19.38)	0.980/1.000 (24.89/25.40)	0.088/0.090 (2.24/2.29)	0.092/0.103 (2.34/2.62)	A +0.480 (12.19)	B -0.480 (-12.19)	0.500±0.020 (12.70±0.51)



Design Parameters

Many factors can affect the seal performance and service life, all of which should be considered when determining the most suitable gland design parameters for an application. For more information, refer to Bal Seal Technical Report TR-78, *Factors that Influence Bal Seal® Performance*. We also manufacture non-standard seals that accommodate larger tolerances.

Recommended Shaft and Housing Tolerances

Shaft Diameter Range in. (mm)	Recommended Tolerance			
	Shaft Dimension in. (mm)		Housing Dimension in. (mm)	
	Min.	Max.	Min.	Max.
0.020 to 0.999 (0.50 to 24.99)	-0.0005 (-0.01)	+0.0000 (0.00)	-0.0000 (0.00)	+0.0005 (0.01)
1.000 to 1.999 (25.00 to 49.99)	-0.0010 (-0.03)	+0.0000 (0.00)	-0.0000 (0.00)	+0.0010 (0.03)
2.000 to 3.499 (50.00 to 89.99)	-0.0015 (-0.04)	+0.0000 (0.00)	-0.0000 (0.00)	+0.0015 (0.04)
3.500 to 5.999 (90.00 to 149.99)	-0.0020 (-0.05)	+0.0000 (0.00)	-0.0000 (0.00)	+0.0020 (0.05)
6.000 to 14.999 (150.00 to 379.99)	-0.0030 (-0.08)	+0.0000 (0.00)	-0.0000 (0.00)	+0.0030 (0.08)
15.000 to 33.900 (380.00 to 859.99)	-0.0040 (-0.10)	+0.0000 (0.00)	-0.0000 (0.00)	+0.0040 (0.10)
34.000 to 120.000 (860.00 to 3048.00)	-0.0050 (-0.13)	+0.0000 (0.00)	-0.0000 (0.00)	+0.0050 (0.13)

Radial Clearance

Extrusion is the flowing of the seal ring material into the radial clearance (E) of the seal gland, which is due to the media pressure acting on the seal's internal cavity. Excessive extrusion can result in seal lip blowout and failure. The extrusion of the seal material increases as the pressure and/or radial clearance (E) increases. Extrusion can also be influenced by other factors, such as temperature and seal material. A backup ring should be used if the "E" clearance cannot be controlled as required. Refer to Bal Seal application bulletin PN-228 for additional extrusion information.

E Typical Radial Clearance @70 °F (21 °C)						
Cross Section		H Nominal Gland Height in. (mm)	Pressure psi (bar)			
Code	Size		150 (10)	1,500 (103)	3,000 (207)	10,000 (689)
2	1/64	0.016 (0.40)	0.001 (0.025)	0.001 (0.025)	0.0005 (0.013)	0.0005 (0.013)
1	1/32	0.031 (0.79)	0.002 (0.051)	0.002 (0.051)	0.001 (0.025)	0.0005 (0.013)
0	1/16	0.062 (1.57)	0.004 (0.102)	0.003 (0.076)	0.002 (0.051)	0.001 (0.025)
4	3/32	0.094 (2.39)	0.005 (0.127)	0.003 (0.076)	0.002 (0.051)	0.001 (0.025)
5	1/8	0.125 (3.18)	0.006 (0.152)	0.004 (0.102)	0.003 (0.076)	0.0015 (0.038)
6	3/16	0.187 (4.75)	0.007 (0.178)	0.004 (0.102)	0.003 (0.076)	0.0015 (0.038)
7	1/4	0.250 (6.35)	0.008 (0.203)	0.005 (0.127)	0.004 (0.102)	0.002 (0.051)
8	3/8	0.375 (9.35)	0.010 (0.254)	0.006 (0.152)	0.005 (0.127)	0.002 (0.051)
9	1/2	0.500 (12.70)	0.012 (0.305)	0.007 (0.178)	0.006 (0.152)	0.003 (0.076)



Dynamic Surface Hardness

A dynamic surface with a higher hardness will reduce adhesion of the seal ring material onto that surface, thereby reducing friction and consequently reducing premature seal wear. Some materials require elevated hardness to ensure longevity of the dynamic surfaces.

Surface Finish

The surface finish of the dynamic material has a substantial effect on the seal performance. In general, the better the surface finish, the better the seal performance. A good surface finish results in better sealing ability, lower abrasive wear, and longer seal life. Small imperfections such as scratches, cutter tool marks, porosity, and eccentricities can create leakage paths, depending on the media type and pressure, and should be minimized whenever possible. Refer to Bal Seal technical report TR-4, *The Influence of Surface Finish on Bal Seal® Performance*.

Suggested Surface Finishes

Medium	Dynamic Surface (Reciprocating)		Static Surface	
	RMS	Ra $\mu\text{in.}$ (Ra μm)	RMS	Ra $\mu\text{in.}$ (Ra μm)
Cryogens	2 to 4	1.8 to 3.6 (0.045 to 0.09)	4 to 8	3.6 to 7.2 (0.09 to 0.18)
Gases (air, N, O, etc.)	6 to 12	5.4 to 10.8 (0.135 to 0.27)	12 to 32	10.8 to 28.8 (0.27 to 0.72)
Liquids (hydraulic fluid, water, etc.)	8 to 16	7.2 to 14.4 (0.18 to 0.36)	16 to 32	14.4 to 28.8 (0.36 to 0.72)

Assembly and Installation Configurations

Assembly of Bal Seal® spring-energized seals into stepped piston grooves present the potential for permanently deforming the seal, thereby reducing the sealing ability and seal life. Therefore, we recommend the use of a split gland whenever possible. Sometimes small diameter seals cannot be stretched enough to install into a stepped gland (See Minimum and Maximum IDs for Stepped Pistons on page 16). Stepped pistons are generally classified as solid, 1/2 or 1/4 step. Any fraction between 0 and 1 is possible. Seal installation is greatly eased by a smaller step.

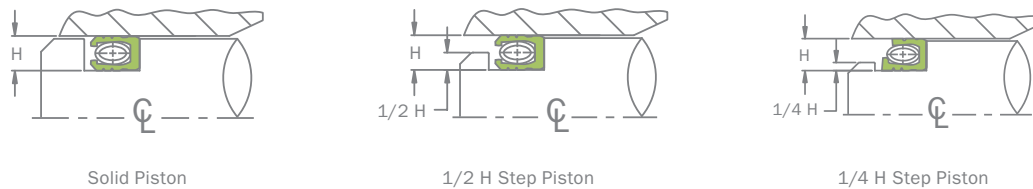

The same concept applies to housing grooves. Installing a plastic seal into an ID stepped groove can be very challenging. Typically only manual installation is possible, depending on the seal diameter.

We suggest using assembly tools such as those shown in the illustrations to reduce the risk of seal damage during installation into a gland. The assembly tools provide a suitable lead-in taper and guide the seal into the gland. The collet assembly tool gradually stretches the seal over the piston and into the gland. Resizing the seal after stretching it on to a stepped gland is essential. For details on assembly procedures and limitations, request Bal Seal technical report TR-6.2. We can also supply dimensional information for fabricating assembly tools for specific applications.

Manual Assembly of a Seal onto a Stepped Piston

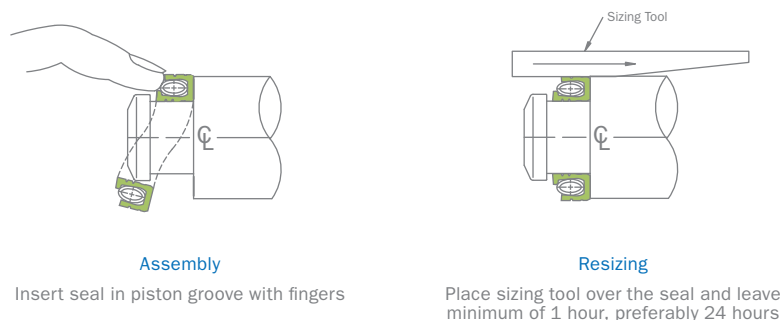



Assembly of a Seal onto a Stepped Piston Using a Tool

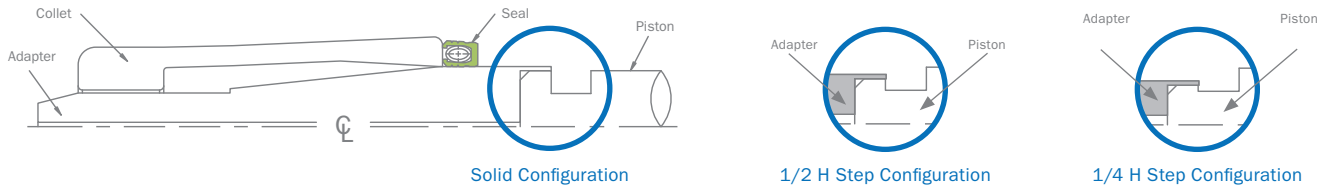

Seal Assembly

Using a seal assembly adapter, push the seal into the piston gland with an assembly collet

Resizing a Seal in a Gland

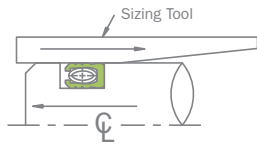

Place sizing tool over the seal and leave minimum of 1 hour, preferably 24 hours

Assembly of a Seal into Split Gland Housing Using a Tool

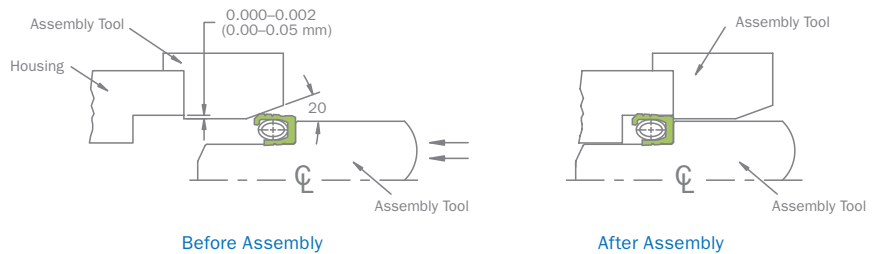

Minimum and Maximum IDs for Stepped Pistons

Recommended Seal ID Range for Assembly with Tools Based on Cross Section and Step Piston Configurations

Cross Section Code	1/4 H Step Gland		1/2 H Step Gland		Solid Gland	
	Minimum in. (mm)	Maximum in. (mm)	Minimum in. (mm)	Maximum in. (mm)	Minimum in. (mm)	Maximum in. (mm)
0	0.219 (5.56)	1.875 (47.63)	0.312 (7.92)	1.875 (47.63)	0.500 (12.70)	1.875 (47.63)
4	0.312 (7.92)	2.875 (73.03)	0.375 (9.53)	2.875 (73.03)	0.625 (15.88)	2.875 (73.03)
5	0.625 (15.88)	3.750 (95.25)	1.000 (25.40)	3.750 (95.25)	1.250 (31.75)	3.750 (95.25)
6	1.000 (25.40)	5.625 (142.88)	1.250 (31.75)	5.625 (142.88)	1.500 (38.10)	5.625 (142.88)

Recommended Seal ID Range for Manual Assembly Based on Cross Section Only for a 1/4 H Step Piston

Cross Section Code	1/4 H Step Gland	
	Minimum in. (mm)	Maximum in. (mm)
0	0.312 (7.92)	1.875 (47.63)
4	0.438 (11.13)	2.875 (73.03)
5	0.750 (19.05)	3.750 (95.25)
6	1.125 (28.58)	5.625 (142.88)

Guide Rings

Spring-energized guide rings, which are made from PTFE-based materials, are used with Bal Seal® fluid seals to help prevent metal-to-metal contact and provide piston guidance and support. Our guide rings differ from conventional wear rings in one major respect: our unique Bal Spring® canted coil spring supports the weight of the piston or rod evenly around the circumference, and it compensates for wear.

Selection between light, medium, and heavy spring forces tailor the guide ring for a suitable mix of friction and piston support. Provide our technical sales staff with your application details, and we'll propose the optimal guide ring material and spring force combination.

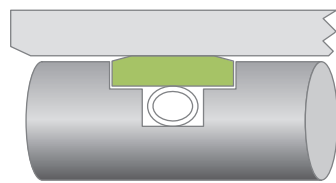

Guide Ring
Piston Mounted PW Series

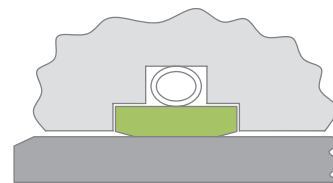

Guide Ring
Housing Mounted HW Series

Piston Support

Guide Rings vs. Conventional Wear Rings

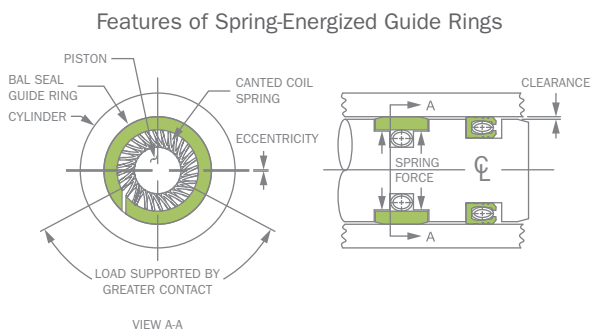

- Supports piston weight
- Reduces bearing load
- Reduces cylinder scoring
- Minimizes side loading
- Compensates for wear

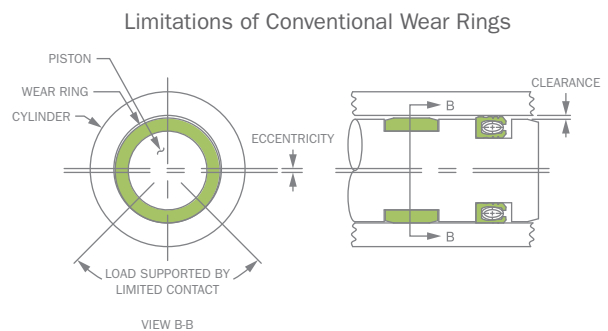

- Overcome by weight of piston
- Increases stress
- Allows metal-to-metal contact
- Succumbs to side loading
- Accelerates wear

Improved Seal Performance

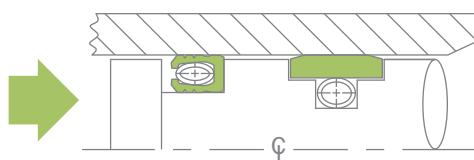

Piston Mounted PW Series Guide Ring
with a Low-Friction Bal Seal®

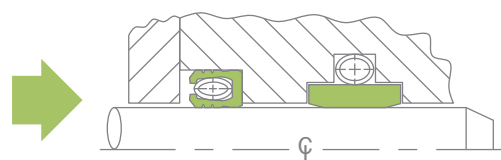

Housing Mounted HW Series Guide Ring
with a Low-Friction Bal Seal®



Bal Seal® Static/Face Seals

Our static/face seals assemble into a gland, flange, or counterbore for internal or external pressure, static, or dynamic sealing. Because the Bal Spring® canted coil spring energizer provides nearly constant load over a wide range of deflection, variations in gland depth tolerance have a minimal effect on seal load. PTFE-based seal materials make the seal compatible with a variety of liquid and gas applications.

Internal Pressure

The spring cavity on the seal ID allows the internal pressure to aid in providing a positive seal as pressure increases. A heavy spring force is typical for static applications. Lighter spring forces can customize the load for dynamic service and applications that require lower friction.

Seal Designs:

S15, S2, US15, US2

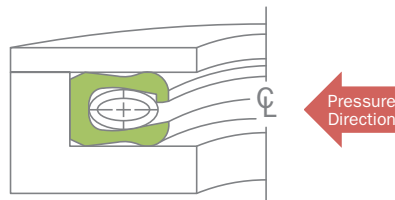

Internal Pressure

External Pressure

The spring cavity on the seal ID aids in providing a positive seal under external pressure. A heavy spring force is typically specified for static and vacuum service. Lighter spring forces can customize the load for dynamic service and applications that require lower friction.

Seal Designs:

IS15, IS2, UIS15, UIS2

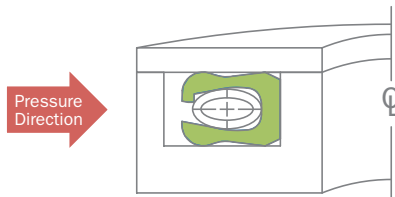

External Pressure

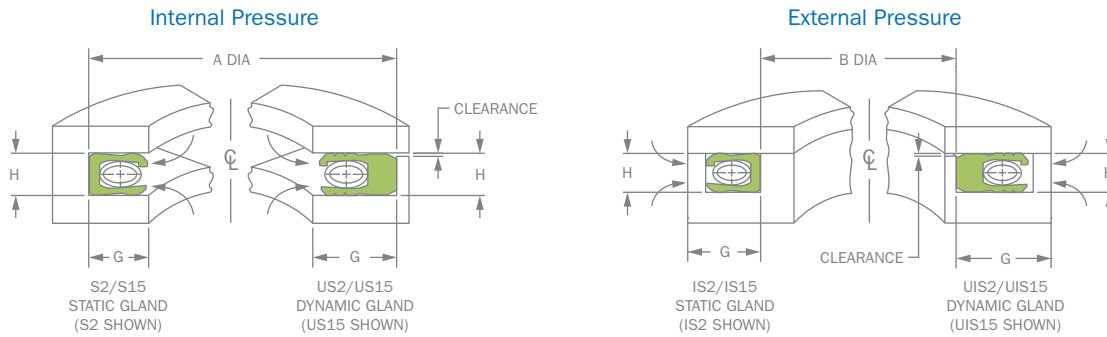

Static/Face Seal Gland Dimensions

Cross Section		H Gland Height in. (mm)	G Gland Length in. (mm)	
Code	Size		S/IS Series Seals Minimum	US/UIS Series Seals Minimum
0	1/16	0.061/0.063 (1.55/1.60)	0.115 (2.92)	0.155 (3.94)
4	3/32	0.093/0.095 (2.36/2.41)	0.155 (3.94)	0.195 (4.95)
5	1/8	0.125/0.127 (3.18/3.23)	0.195 (4.95)	0.275 (6.99)
6	3/16	0.187/0.189 (4.75/4.80)	0.275 (6.99)	0.365 (9.27)
7	1/4	0.250/0.252 (6.35/6.40)	0.365 (9.27)	0.535 (13.59)
8	3/8	0.375/0.377 (9.53/9.58)	0.535 (13.59)	0.715 (18.16)
9	1/2	0.500/0.502 (12.70/12.75)	0.715 (18.16)	0.935 (23.75)

We also manufacture non-standard seals that accommodate larger tolerances.

The larger gland height (H) for dynamic applications reduces breakout and dynamic friction. Smaller gland height for static applications improves sealing reliability.



Bal Seal® Static/Face Seals

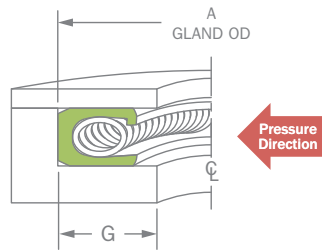

S Series Seals

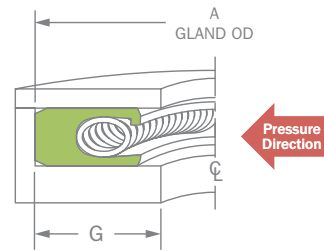

US Series Seals
(Extended Heel)

Internal Pressure

Cross Section		S Series		US Series	
Code	Size	A Gland OD in. (mm)	Tolerance in. (mm)	A Gland OD in. (mm)	Tolerance in. (mm)
0	1/16	0.312 to 0.625 (7.92 to 15.88)	+0.001 (+0.005) -0.000 (-0.000)	0.437 to 0.625 (11.10 to 15.88)	+0.001 (+0.003) -0.000 (-0.000)
4	3/32	0.875 to 1.500 (22.23 to 38.10)	+0.001 (+0.030) -0.000 (-0.000)	1.750 to 2.250 (44.45 to 57.15)	+0.002 (+0.050) -0.000 (-0.000)
5	1/8	1.125 to 1.625 (28.58 to 41.28)	+0.001 (+0.030) -0.000 (-0.000)	1.750 to 2.500 (44.45 to 63.50)	+0.002 (+0.050) -0.000 (-0.000)
6	3/16	3.000 to 3.750 (76.20 to 95.25)	+0.003 (+0.080) -0.000 (-0.000)	4.000 to 4.500 (101.60 to 114.30)	+0.004 (+0.100) -0.000 (-0.000)
7	1/4	4.000 to 5.000 (101.60 to 127.00)	+0.004 (+0.100) -0.000 (-0.000)	5.250 to 6.000 (133.35 to 152.40)	+0.005 (+0.130) -0.000 (-0.000)
8	3/8	6.500 to 72.000 (165.10 to 1828.80)	+0.010 (+0.300) -0.000 (-0.000)	6.500 to 72.000 (165.10 to 1828.80)	+0.010 (+0.300) -0.000 (-0.000)
9	1/2	12.500 to 72.000 (317.50 to 1828.80)	+0.015 (+0.380) -0.000 (-0.000)	12.500 to 72.000 (317.50 to 1828.80)	+0.015 (+0.380) -0.000 (-0.000)

We also manufacture non-standard seals that accommodate larger tolerances.

Only common sizes are shown. For special cross sections and diameters, please contact us to discuss your application requirements.

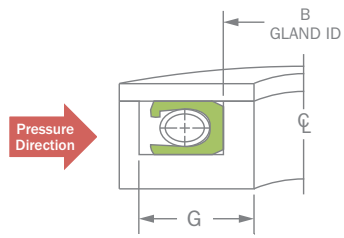

IS Series Seals

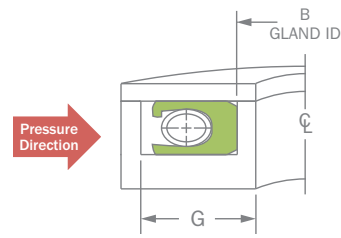

UIS Series Seals
(Extended Heel)

External Pressure

Cross Section		IS Series		UIS Series	
Code	Size	B Gland ID in. (mm)	Tolerance in. (mm)	B Gland ID in. (mm)	Tolerance in. (mm)
0	1/16	0.187 to 0.750 (4.75 to 19.05)	+0.000 (+0.000) -0.001 (-0.030)	0.187 to 0.750 (4.75 to 19.05)	+0.000 (+0.000) -0.001 (-0.030)
4	3/32	0.875 to 1.500 (15.88 to 38.10)	+0.000 (+0.000) -0.001 (-0.030)	1.750 to 2.250 (44.45 to 57.15)	+0.000 (+0.000) -0.002 (-0.050)
5	1/8	1.125 to 1.625 (28.58 to 41.28)	+0.000 (+0.000) -0.001 (-0.030)	1.750 to 2.500 (44.45 to 63.50)	+0.000 (+0.000) -0.002 (-0.050)
6	3/16	3.000 to 3.750 (76.20 to 95.25)	+0.000 (+0.000) -0.003 (-0.080)	4.000 to 4.500 (101.60 to 114.30)	+0.000 (+0.000) -0.004 (-0.010)
7	1/4	4.000 to 5.000 (101.60 to 127.00)	+0.000 (+0.000) -0.004 (-0.100)	5.250 to 6.000 (133.35 to 152.40)	+0.000 (+0.000) -0.005 (-0.130)
8	3/8	6.500 to 72.000 (165.10 to 1828.80)	+0.000 (+0.000) -0.010 (-0.300)	6.500 to 72.000 (165.10 to 1828.80)	+0.000 (+0.000) -0.010 (-0.300)
9	1/2	12.500 to 72.000 (317.50 to 1828.80)	+0.000 (+0.000) -0.015 (-0.380)	12.500 to 72.000 (317.50 to 1828.80)	+0.000 (+0.000) -0.015 (-0.380)



Typical Bal Seal® Spring-Energized Seal Applications

HPLC Plunger Pump

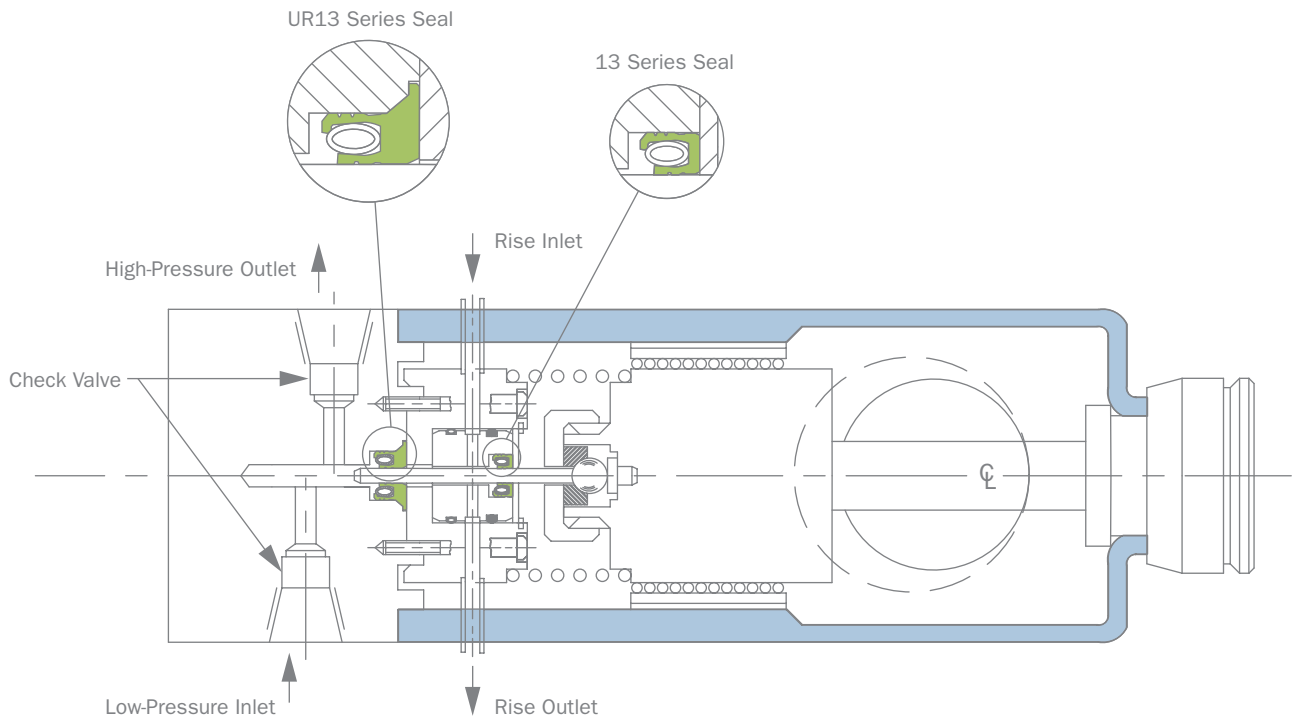

Operating Parameters	
Pressure	Atmospheric to 14,000 psi (965 bar)
Media	ACN, methanol, deionized H ₂ O
Speed	4 ft/min (0.02 m/s)
Temperature	32–100 °F (0°–38 °C)

Surgical Bone Saw

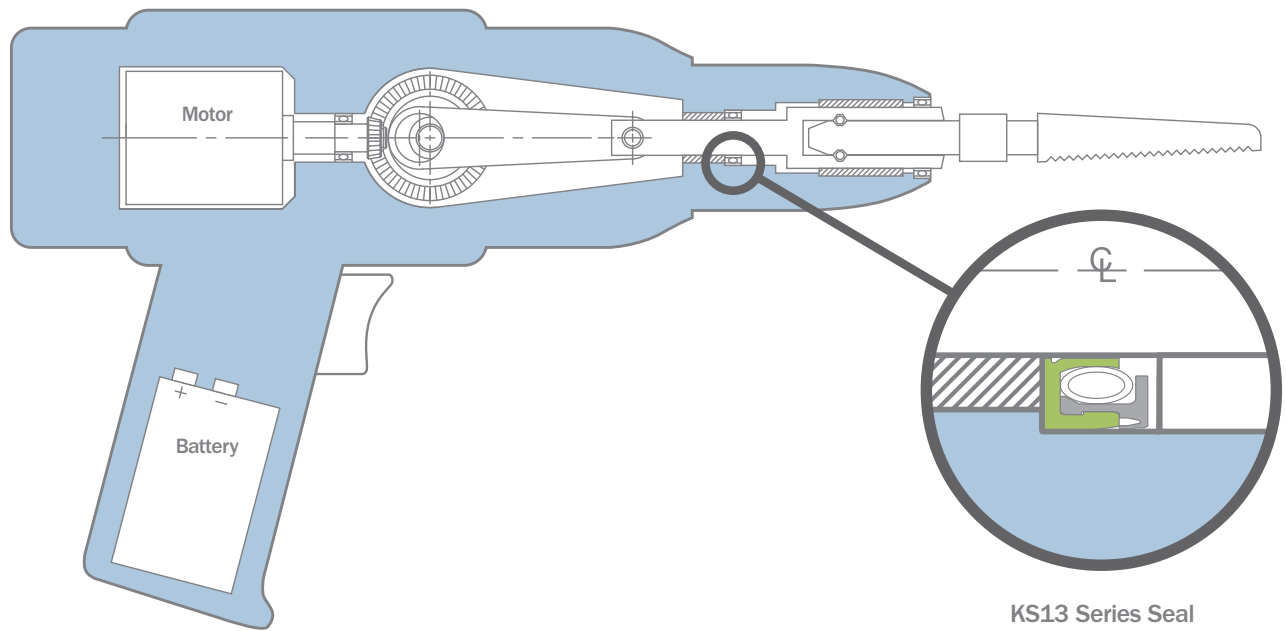

Operating Parameters	
Pressure	Atmospheric to 15 psi (1 bar)
Media	Bone, tissue, bearing grease, and sterilization fluids
Speed	50–300 ft/min (0.25–1.5 m/s)
Temperature	70 °F (21 °C) operating 250 °F (121 °C) autoclave cleaning



Customized Solution Examples

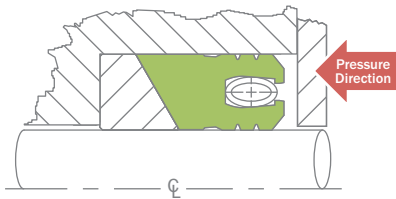

High-Pressure Seal with Tapered Backup

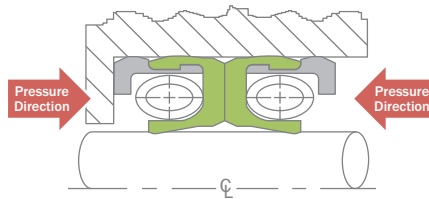

Bi-directional Seal at Low Pressure

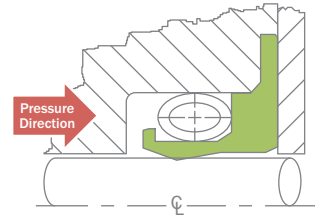

Cryogenic Seal, Very Low Pressure



Double Spring Seal

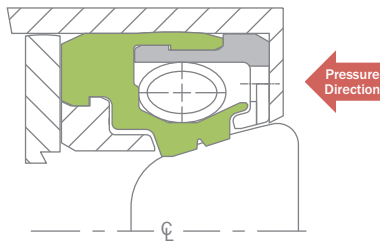

Anti-blowout Seal

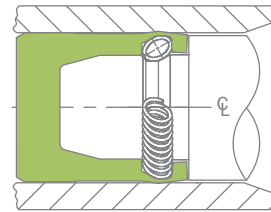

Cover Seal

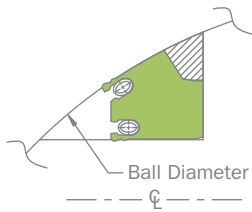

Ball Valve Seal

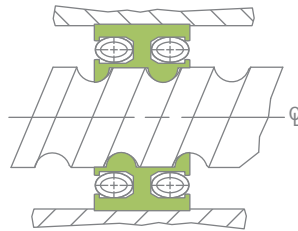

Ball Screw Seal

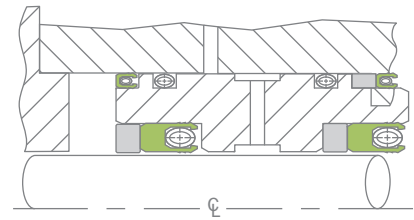

Bearing-Seal Package

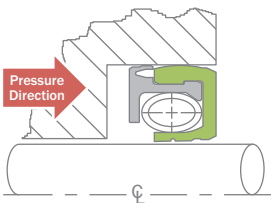

Reverse Pressure Direction
15 psi max. ΔP

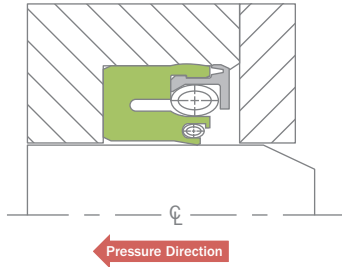

Large Deflections

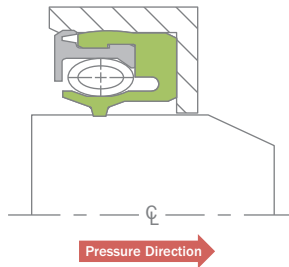

Extreme Misalignment

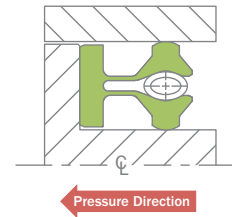

Extremely Low Friction

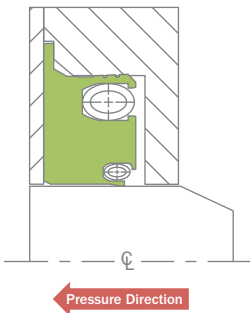

Unusual Gland Configurations

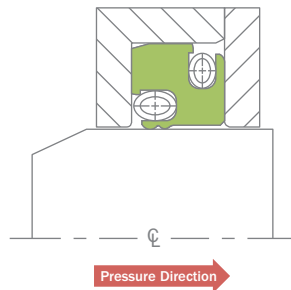

Multidirection Sealing

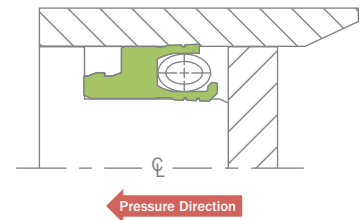

Snapped in Backup Ring Assembly

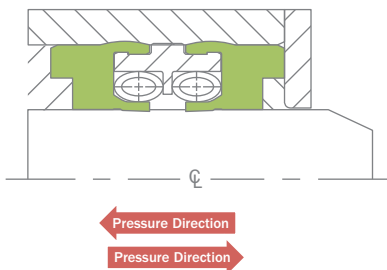

Bi-Directional Pressure

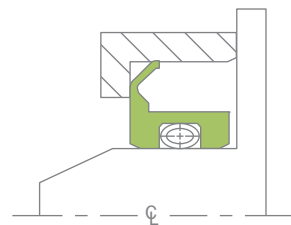

Extremely High Rotational Speeds

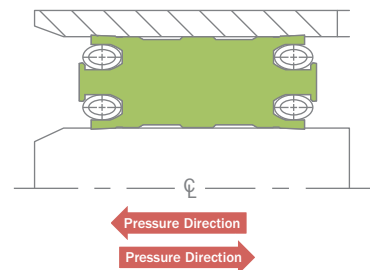

Floating Cover Seal

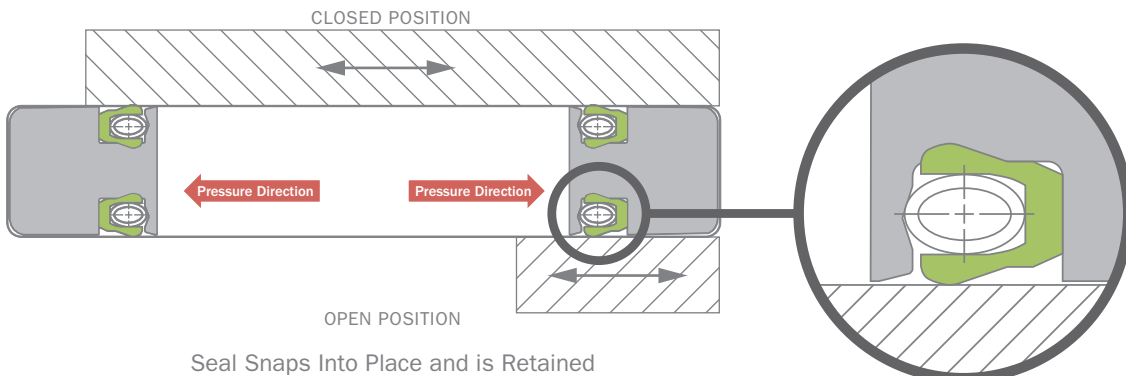

Seal Snaps Into Place and is Retained



Design Request Form—Reciprocating/Radial Seals

In order to design your Bal Seal® reciprocating/radial sealing solution, we need to know more about your application requirements. Please complete this form and e-mail it to us at sales@balseal.com, or fax it to (949) 460-2300.

Name	Date
Company	Title
Address	Department
City, State & Zip	Telephone
E-mail	Fax

Product data		Service	
Equipment type		<input type="checkbox"/> Reciprocating <input type="checkbox"/> Intermittent <input type="checkbox"/> Other	
Application is used for		Travel length <input type="checkbox"/> in. <input type="checkbox"/> cm	
<input type="checkbox"/> Prototype <input type="checkbox"/> Production <input type="checkbox"/> Retrofit <input type="checkbox"/> Other		Speed	
Annual usage	Target price (per unit)	<input type="checkbox"/> fpm <input type="checkbox"/> cpm <input type="checkbox"/> rpm <input type="checkbox"/> m/s	

Critical factors			Temperature		
	Value	Assign order of priority, 1 (highest) to 5 (lowest)	Minimum	<input type="checkbox"/> °C <input type="checkbox"/> °F <input type="checkbox"/> °K	
Friction			Operating	<input type="checkbox"/> °C <input type="checkbox"/> °F <input type="checkbox"/> °K	
Service life			Maximum	<input type="checkbox"/> °C <input type="checkbox"/> °F <input type="checkbox"/> °K	
Sealing performance			Does seal reach operating temperature before pressure is applied? <input type="checkbox"/> Yes <input type="checkbox"/> No		
Compatibility			Does seal reach cold temperatures prior to pressurizing? <input type="checkbox"/> Yes <input type="checkbox"/> No		
Cost			What is maximum temperature that maximum pressure will see?		

Media type (Please select all that apply)		Pressure			
<input type="checkbox"/> Gas <input type="checkbox"/> Abrasives <input type="checkbox"/> Contaminant <input type="checkbox"/> Liquid <input type="checkbox"/> Solid particles (size=) <input type="checkbox"/> Other <input type="checkbox"/> Viscous <input type="checkbox"/> Corrosive		Minimum	<input type="checkbox"/> psi <input type="checkbox"/> MPa <input type="checkbox"/> kg/cm ² <input type="checkbox"/> bar		
Specific gravity		Operating	<input type="checkbox"/> psi <input type="checkbox"/> MPa <input type="checkbox"/> kg/cm ² <input type="checkbox"/> bar		
Volatiles		Maximum	<input type="checkbox"/> psi <input type="checkbox"/> MPa <input type="checkbox"/> kg/cm ² <input type="checkbox"/> bar		
Relative humidity					
Viscosity <input type="checkbox"/> cP <input type="checkbox"/> cSt					

Friction force		Differential pressure across seal			
<input type="checkbox"/> lbs. <input type="checkbox"/> N		<input type="checkbox"/> psi <input type="checkbox"/> MPa <input type="checkbox"/> kg/cm ² <input type="checkbox"/> bar			
Breakout	Running		Minimum	Operating	Maximum
		Forward shaft travel			
		Reverse shaft travel			

Dimensional information				Vacuum	
	<input type="checkbox"/> Inches <input type="checkbox"/> mm	Tolerance (+/-)	Can be modified	<input type="checkbox"/> in Hg <input type="checkbox"/> Pa <input type="checkbox"/> Torr	
Shaft diameter (A)			<input type="checkbox"/>	Bore information	
Bore diameter (B)			<input type="checkbox"/>	Material	
Gland length (C)			<input type="checkbox"/>	Plating/coating	
Gland height (D)			<input type="checkbox"/>	Hardness (Rc)	
Radial shaft/bore clearance (E)			<input type="checkbox"/>	Surface finish <input type="checkbox"/> RMS <input type="checkbox"/> Ra	

Eccentricity		Shaft information	
Shaft-to-Bore Misalignment		Material	
		Plating/coating	
		Hardness (Rc)	
		Surface finish <input type="checkbox"/> RMS <input type="checkbox"/> Ra	

Gland configurations			
<input type="checkbox"/> 2-piece housing 	<input type="checkbox"/> 2-piece piston 	<input type="checkbox"/> 1-piece piston (stepped gland) 	<input type="checkbox"/> Flanged bore

Can you supply shaft/bore/gland drawings? Yes No

Design Request Form—Static/Face Seals

In order to design your Bal Seal® static/face sealing solution, we need to know more about your application requirements. Please complete this form and e-mail it to us at sales@balseal.com, or fax it to (949) 460-2300.

Name	Date
Company	Title
Address	Department
City, State & Zip	Telephone
E-mail	Fax

Product data		Service	
Equipment type		<input type="checkbox"/> Oscillating	<input type="checkbox"/> Static
Application is used for		<input type="checkbox"/> Dynamic	<input type="checkbox"/> Other
<input type="checkbox"/> Prototype	<input type="checkbox"/> Production	Degrees rotated	Travel length <input type="checkbox"/> in. <input type="checkbox"/> cm
<input type="checkbox"/> Retrofit	<input type="checkbox"/> Other	Speed	
Annual usage	Target price (per unit)	<input type="checkbox"/> fpm	<input type="checkbox"/> cpm
		<input type="checkbox"/> rpm	<input type="checkbox"/> m/s

Critical factors			Temperature			
	Value	Assign order of priority, 1 (highest) to 5 (lowest)	Minimum	<input type="checkbox"/> °C	<input type="checkbox"/> °F	<input type="checkbox"/> °K
Friction			Operating	<input type="checkbox"/> °C	<input type="checkbox"/> °F	<input type="checkbox"/> °K
Service life			Maximum	<input type="checkbox"/> °C	<input type="checkbox"/> °F	<input type="checkbox"/> °K
Sealing performance			Does seal reach operating temperature before pressure is applied?			
Compatibility			<input type="checkbox"/> Yes <input type="checkbox"/> No			
Cost			Does seal reach cold temperatures prior to pressurizing?			
			<input type="checkbox"/> Yes <input type="checkbox"/> No			
			What is maximum temperature that maximum pressure will see?			

Media type (Please select all that apply)		Pressure	
<input type="checkbox"/> Gas	<input type="checkbox"/> Abrasives	Minimum	<input type="checkbox"/> psi
<input type="checkbox"/> Liquid	<input type="checkbox"/> Solid particles (size=)	Operating	<input type="checkbox"/> MPa
<input type="checkbox"/> Viscous	<input type="checkbox"/> Corrosive	Maximum	<input type="checkbox"/> kg/cm ²
			<input type="checkbox"/> bar
Specific gravity	Relative humidity	Differential pressure across seal	
Volatiles	Viscosity <input type="checkbox"/> cP <input type="checkbox"/> cSt	<input type="checkbox"/> psi	
		<input type="checkbox"/> MPa	
		<input type="checkbox"/> kg/cm ²	
		<input type="checkbox"/> bar	

Friction force		Vacuum	
<input type="checkbox"/> lbs.	<input type="checkbox"/> N	<input type="checkbox"/> in Hg	
Breakout	Running	<input type="checkbox"/> Pa	
		<input type="checkbox"/> Torr	

Dimensional information				Gland/Bore information	
	<input type="checkbox"/> Inches	Tolerance (+/-)	Can be modified	Material	
	<input type="checkbox"/> mm			Plating/coating	
Inside diameter (B)			<input type="checkbox"/>	Hardness (Rc)	
Outside diameter (A)			<input type="checkbox"/>	Surface finish <input type="checkbox"/> RMS <input type="checkbox"/> Ra	
Gland length (G)			<input type="checkbox"/>	Cover plate information	
Gland height (H)			<input type="checkbox"/>	Material	
Clearance			<input type="checkbox"/>	Plating/coating	
				Hardness (Rc)	
				Surface finish <input type="checkbox"/> RMS <input type="checkbox"/> Ra	

Gland configurations			
<input type="checkbox"/> Internal pressure	<input type="checkbox"/> Internal pressure	<input type="checkbox"/> External pressure	<input type="checkbox"/> External pressure
Static Gland	Dynamic Gland	Static Gland	Dynamic Gland

Can you supply shaft/bore/gland drawings? Yes No



Important Information

CLEANING

Bal Seal Engineering products may require cleaning and/or sterilization before use, depending on the application.

TESTING

It is essential that the customer run evaluation tests to determine if the proposed, supplied, or purchased Bal Seal Engineering products are suitable for the intended purpose. Tests should be run under actual service conditions with an adequate safety factor.

Welded springs have an increased probability of breaking or failing at or near the weld. This probability is magnified if the spring is used in an application involving extension of the spring. In addition, temperature affects the properties of the spring (i.e., tensile strength, elongation, etc.) Failure of Bal Seal Engineering products can cause equipment failure, property damage, personal injury, or death. Equipment containing Bal Seal Engineering products must be designed to provide for any eventuality that may result from a partial or total failure of Bal Seal Engineering products.

Bal Seal Engineering products must be tested with a sufficient safety factor after installation and they must be subjected to a program of regular maintenance and inspection. The customer, through analysis and testing, is solely responsible for making the final selection of the products and for ensuring that all performance, safety, and other requirements of the application are met.

All information and recommendations contained herein are based on tests Bal Seal Engineering believes to be reliable, but the accuracy or completeness is not guaranteed. Any such information or recommendation is given solely for purposes of illustration and is not to be construed as a warranty that any goods will conform to such information or recommendation. No one, including Bal Seal Engineering employees, salespersons, representatives, wholesalers, or distributors is authorized to make any warranty or representation and no customer or other user may rely on any such warranty or representation. Bal Seal Engineering reserves the right to make any changes (such as dimensional data, force, torque, materials, pressures, temperatures, surface finishes, surface speed, etc.) without notice to its products and to the contents of this document.

Nothing contained herein or in any of Bal Seal Engineering's literature constitutes a license or recommendation to use any process, or to manufacture, or to use any product in conflict with existing or future patents covering any product material or its use.

DISCLAIMER OF ALL WARRANTIES

The implied warranties of merchantability and fitness for a particular purpose and all other implied warranties are expressly disclaimed. There are no express warranties, except those, if any, specifically enumerated in this document.

LIMITATION OF LIABILITY/REMEDIES

The liability of Bal Seal Engineering, whether as a result of breach of any warranty, failure to provide timely delivery products, product malfunction, negligence or otherwise, shall be limited to repairing or replacing the non-conforming products or any part thereof, or, at Bal Seal Engineering's option, to the repayment to the customer all sums paid by the customer upon return to Bal Seal Engineering of the non-conforming products or part thereof. It is expressly agreed that the customer's remedy, as stated above, shall be exclusive and that under no circumstances shall Bal Seal Engineering be liable for any other damages, including direct, indirect, incidental, or consequential damages (LE-173-5 Rev. 0).

PATENTS

The products described herein include those which are the subject of pending and issued patents, both foreign and domestic, including patents 5,992,856; 6,264,205; 6,161,838; 6,641,141; 7,210,398; (LE-173 Rev. 0) (Report #621-7).

Copyright 2019, Bal Seal Engineering, Inc.



We're more than just a component maker. In early development or existing product improvement stages, we combine our proven seals, springs, and electrical contacts with engineering, material science, and precision manufacturing expertise to produce solutions that break down performance barriers.



Americas

Bal Seal Engineering, Inc.
19650 Pauling, Foothill Ranch, CA 92610-2610
Telephone +1 949 460 2100 or Toll Free +1 800 366 1006
Fax +1 949 460 2300

Europe, Middle East, Africa

Bal Seal Engineering Europe B.V.
Jollemanhof 16, 5th floor, 1019 GW Amsterdam
The Netherlands
Telephone +31 20 638 6523
Fax +31 20 625 6018

Asia Pacific

Bal Seal Asia Limited
Suite 901, Chinachem Century Tower
178 Gloucester Road, Wanchai, Hong Kong
Telephone +852 28681860
Fax +852 22956753



www.balseal.com sales@balseal.com

Custom components that drive tomorrow's technologies.®